

# Werkzeugkatalog

tool catalogue

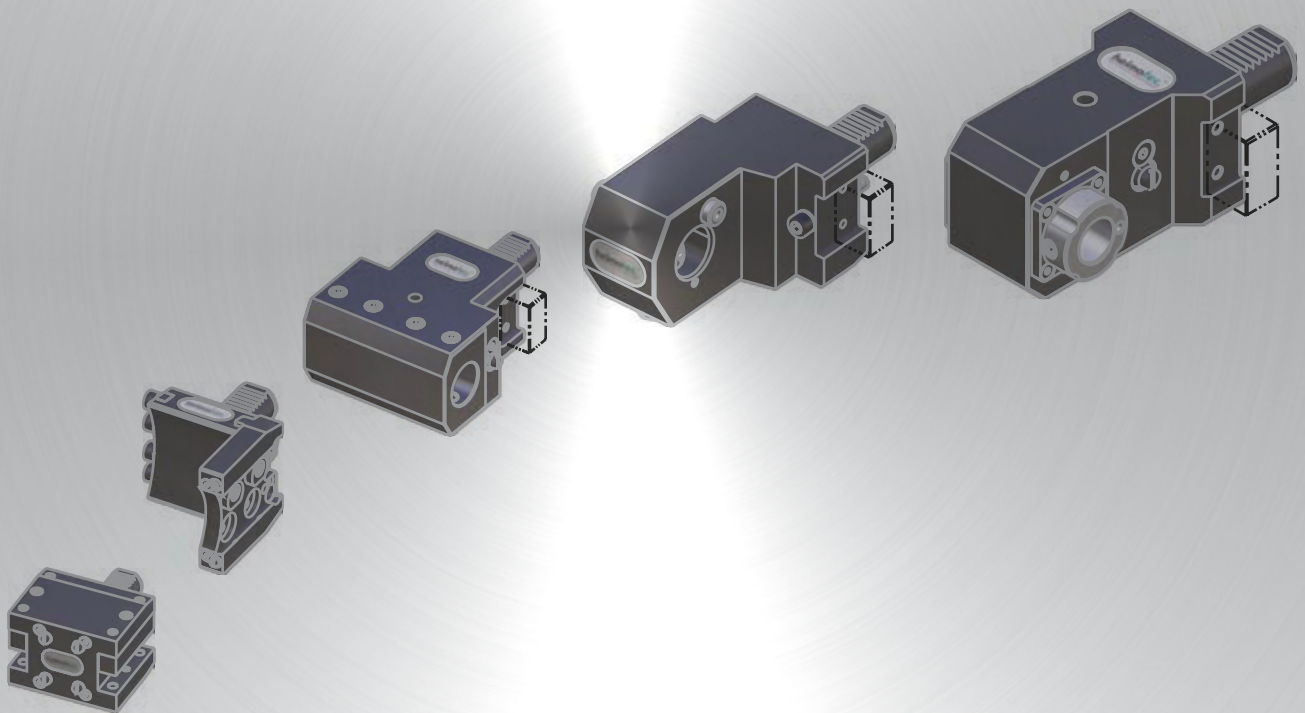

# VDI 30

Sternrevolver  
peripheral turret

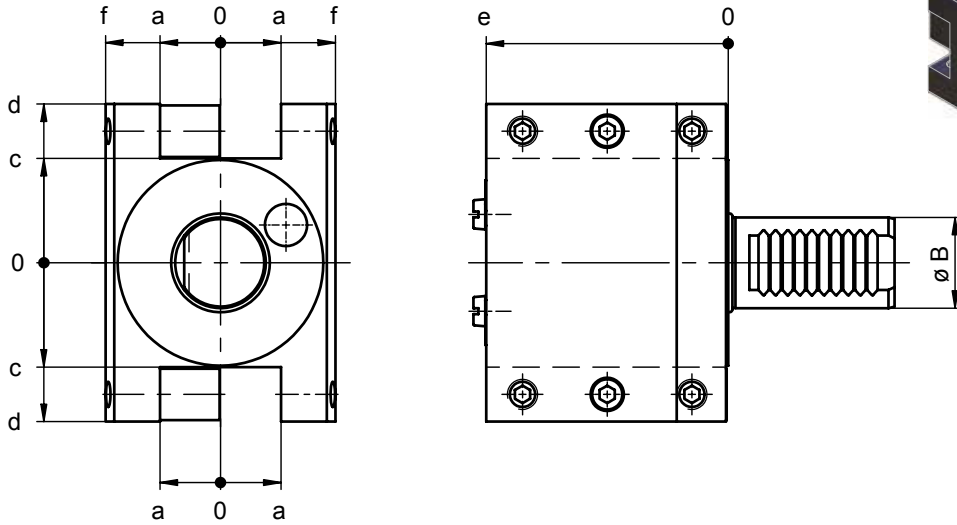

 Darstellung symbolisch  
symbolic drawing

Bestell-Nr. ref.-no.	a [mm]	Ø B [mm]	c [mm]	d [mm]	e [mm]	f [mm]
8 251 24 002	20	30	34,5	52,5	80	38

 ZB 655 ...\*

► Weitere Ausführungen auf Anfrage / further versions on request

\* Nicht im Lieferumfang enthalten  
\* not included in delivery

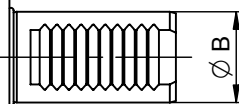
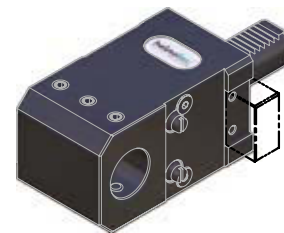
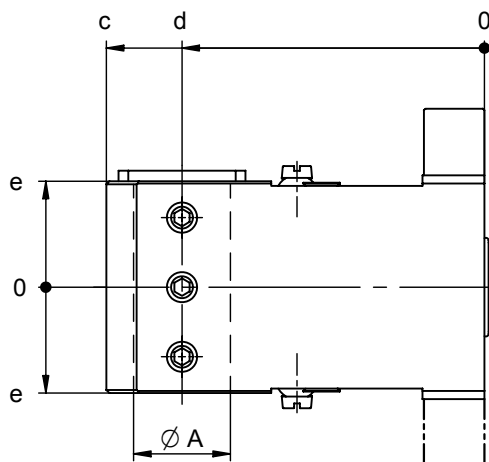
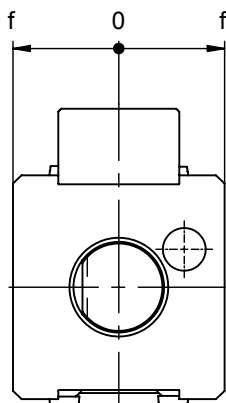



Fixierleisten: siehe  
fixation rails: see  
Figur 1 / Figur 2  
figure 1 / figure 2

- ▶ Ausführung rechts (R): wie gezeichnet  
right-hand version (R): as drawn
- ▶ Ausführung links (L): spiegelbildlich  
left-hand version (L): reversed-image

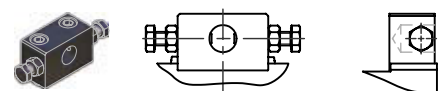

Darstellung symbolisch  
symbolic drawing

Fixierleisten / fixation rails	
 <p>Leiste für Revolver mit Stift rail for turret with pin</p>	 <p>Leiste für Revolver ohne Stift rail for turret without pin</p>

- ▶ Weitere Ausführungen auf Anfrage / further versions on request

Bestell-Nr. ref.-no.	Leiste / rail Figur ... / figure ...	ø A [mm]	ø B [mm]	c [mm]	d [mm]	e [mm]	f [mm]
8 230 27 018	R 1	25	30	110	85	35	35
8 230 27 031	R 2	25	30	110	85	35	35
8 231 27 004	L 1	25	30	110	85	35	35
8 231 27 007	L 2	25	30	110	85	35	35
8 230 28 022	R 1	32	30	110	85	35	35
8 230 28 028	R 2	32	30	110	85	35	35
8 231 28 005	L 1	32	30	110	85	35	35
8 231 28 008	L 2	32	30	110	85	35	35
8 230 29 003	R 1	40	30	110	85	35	35
8 230 29 007	R 2	40	30	110	85	35	35
8 231 29 000	L 1	40	30	110	85	35	35
8 231 29 002	L 2	40	30	110	85	35	35



- ▶ Weitere Ausführungen auf Anfrage / further versions on request

\* Nicht im Lieferumfang enthalten  
\* not included in delivery

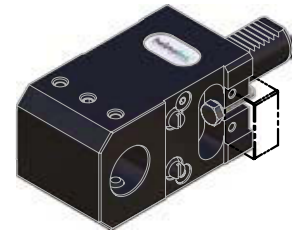
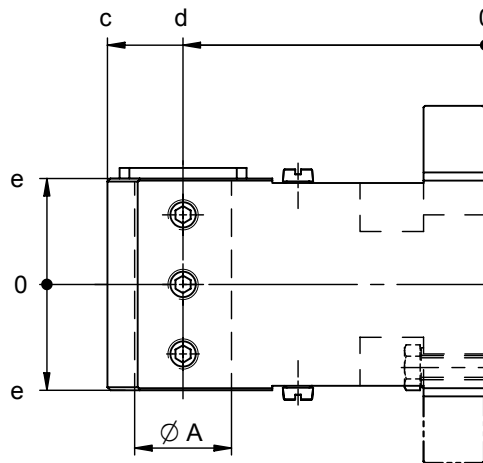
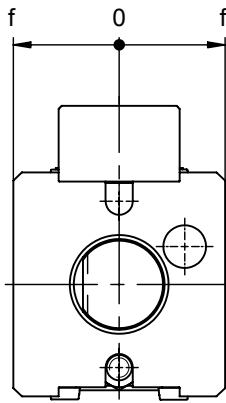



Fixierleisten: siehe  
fixation rails: see  
Figur 1 / Figur 2  
figure 1 / figure 2

 Darstellung symbolisch  
symbolic drawing

- ▶ Ausführung rechts (R): wie gezeichnet  
right-hand version (R): as drawn
- ▶ Ausführung links (L): spiegelbildlich  
left-hand version (L): reversed-image

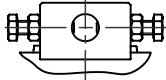
**Fixierleisten / fixation rails**

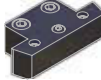
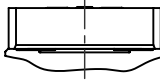
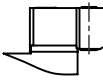
Figur 1 / figure 1			Figur 2 / figure 2		
					
Leiste für Revolver mit Stift rail for turret with pin			Leiste für Revolver ohne Stift rail for turret without pin		

- ▶ Weitere Ausführungen auf Anfrage / further versions on request

Bestell-Nr. ref.-no.	Leiste / rail Figur ... / figure ...	Ø A [mm]	Ø B [mm]	c [mm]	d [mm]	e [mm]	f [mm]
8 230 27 032	R 1	25	30	110	85	35	35
8 230 27 034	R 2	25	30	110	85	35	35
8 231 27 009	L 1	25	30	110	85	35	35
8 231 27 011	L 2	25	30	110	85	35	35
8 230 28 030	R 1	32	30	110	85	35	35
8 230 28 032	R 2	32	30	110	85	35	35
8 231 28 010	L 1	32	30	110	85	35	35
8 231 28 012	L 2	32	30	110	85	35	35
8 230 29 008	R 1	40	30	110	85	35	35
8 230 29 010	R 2	40	30	110	85	35	35
8 231 29 004	L 1	40	30	110	85	35	35
8 231 29 006	L 2	40	30	110	85	35	35

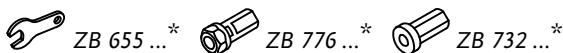

- ▶ Weitere Ausführungen auf Anfrage / further versions on request

\* Nicht im Lieferumfang enthalten  
\* not included in delivery

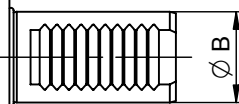
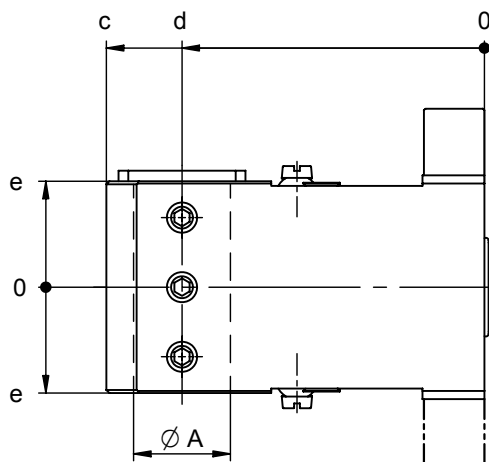
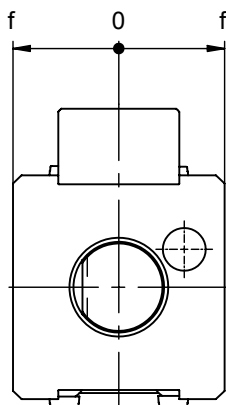



Fixierleisten: siehe  
fixation rails: see  
Figur 1 / Figur 2  
figure 1 / figure 2

- ▶ Ausführung rechts (R): wie gezeichnet  
right-hand version (R): as drawn
- ▶ Ausführung links (L): spiegelbildlich  
left-hand version (L): reversed-image

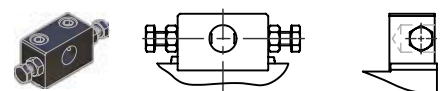

Darstellung symbolisch  
symbolic drawing

Fixierleisten / fixation rails	
 <p>Leiste für Revolver mit Stift rail for turret with pin</p>	 <p>Leiste für Revolver ohne Stift rail for turret without pin</p>

- ▶ Weitere Ausführungen auf Anfrage / further versions on request

Bestell-Nr. ref.-no.	Leiste / rail Figur ... / figure ...	Ø A [mm]	Ø B [mm]	c [mm]	d [mm]	e [mm]	f [mm]
8 230 27 017	R 1	25	30	125	100	35	35
8 230 27 027	R 2	25	30	125	100	35	35
8 231 27 003	L 1	25	30	125	100	35	35
8 231 27 008	L 2	25	30	125	100	35	35
8 230 28 003	R 1	32	30	125	100	35	35
8 230 28 002	R 2	32	30	125	100	35	35
8 231 28 006	L 1	32	30	125	100	35	35
8 231 28 009	L 2	32	30	125	100	35	35
8 230 29 004	R 1	40	30	125	100	35	35
8 230 29 005	R 2	40	30	125	100	35	35
8 231 29 001	L 1	40	30	125	100	35	35
8 231 29 003	L 2	40	30	125	100	35	35

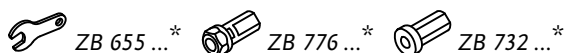

- ▶ Weitere Ausführungen auf Anfrage / further versions on request

\* Nicht im Lieferumfang enthalten  
\* not included in delivery

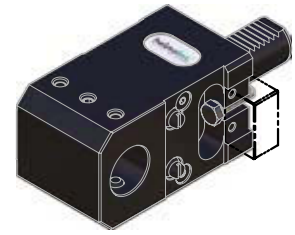
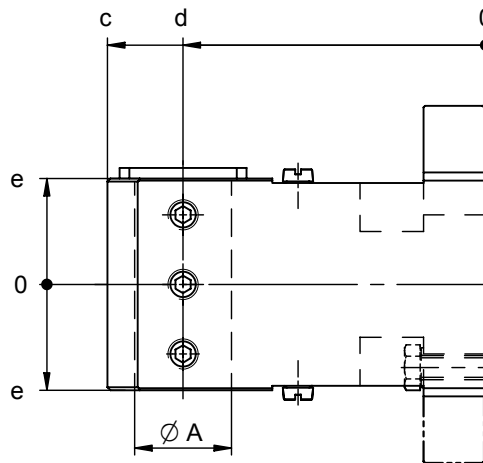
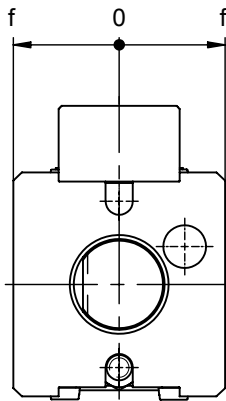

Fixierleisten: siehe  
fixation rails: see  
Figur 1 / Figur 2  
figure 1 / figure 2

 Darstellung symbolisch  
symbolic drawing

- ▶ Ausführung rechts (R): wie gezeichnet  
right-hand version (R): as drawn
- ▶ Ausführung links (L): spiegelbildlich  
left-hand version (L): reversed-image

**Fixierleisten / fixation rails**

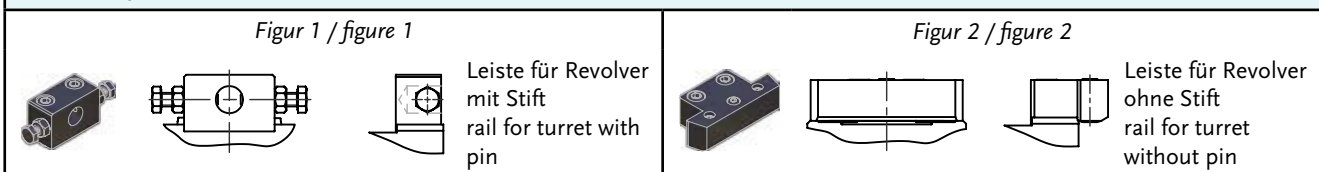

- ▶ Weitere Ausführungen auf Anfrage / further versions on request

Bestell-Nr. ref.-no.	Leiste / rail Figur ... / figure ...	Ø A [mm]	Ø B [mm]	c [mm]	d [mm]	e [mm]	f [mm]
8 230 27 033	R 1	25	30	125	100	35	35
8 230 27 035	R 2	25	30	125	100	35	35
8 231 27 010	L 1	25	30	125	100	35	35
8 231 27 012	L 2	25	30	125	100	35	35
8 230 28 031	R 1	32	30	125	100	35	35
8 230 28 033	R 2	32	30	125	100	35	35
8 231 28 011	L 1	32	30	125	100	35	35
8 231 28 013	L 2	32	30	125	100	35	35
8 230 29 009	R 1	40	30	125	100	35	35
8 230 29 011	R 2	40	30	125	100	35	35
8 231 29 005	L 1	40	30	125	100	35	35
8 231 29 007	L 2	40	30	125	100	35	35

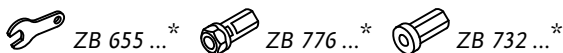

- ▶ Weitere Ausführungen auf Anfrage / further versions on request

\* Nicht im Lieferumfang enthalten  
\* not included in delivery

# Doppel- Bohrstangenhalter

## double boring bar holder

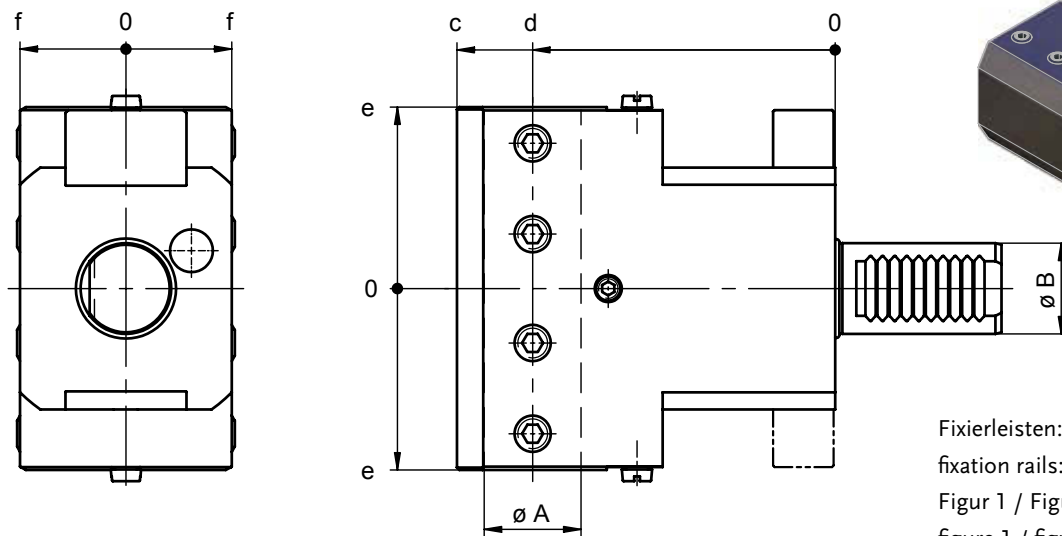

Fixierleisten: siehe  
fixation rails: see  
Figur 1 / Figur 2  
figure 1 / figure 2

 Darstellung symbolisch  
symbolic drawing

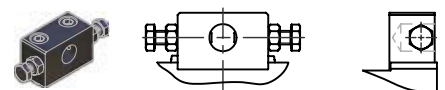
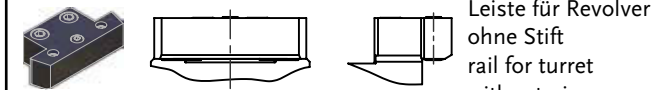
Fixierleisten / fixation rails	
 <p>Figur 1 / figure 1</p> <p>Leiste für Revolver mit Stift rail for turret with pin</p>	 <p>Figur 2 / figure 2</p> <p>Leiste für Revolver ohne Stift rail for turret without pin</p>

► Weitere Ausführungen auf Anfrage / further versions on request

Bestell-Nr. ref.-no.	Leiste / rail Figur ... / figure ...	ø A [mm]	ø B [mm]	c [mm]	d [mm]	e [mm]	f [mm]
8 239 27 009	1	25	30	110	85	60	35
8 239 27 010	2	25	30	110	85	60	35
8 239 28 002	1	32	30	110	85	60	35
8 239 28 008	2	32	30	110	85	60	35
8 239 27 006	1	25	30	125	100	60	35
8 239 27 011	2	25	30	125	100	60	35
8 239 28 000	1	32	30	125	100	60	35
8 239 28 009	2	32	30	125	100	60	35



► Weitere Ausführungen auf Anfrage / further versions on request

\* Nicht im Lieferumfang enthalten  
\* not included in delivery

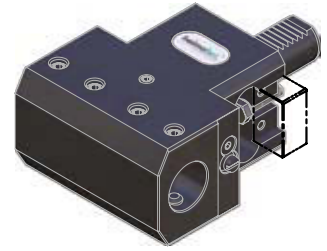
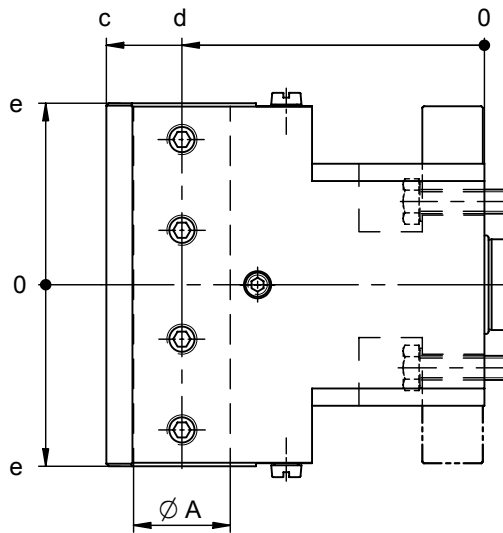
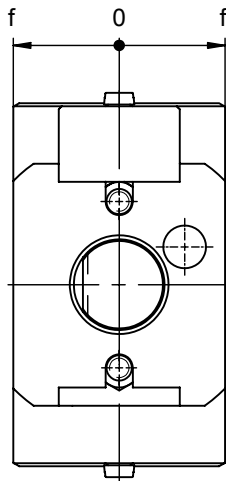

Fixierleisten: siehe  
fixation rails: see  
Figur 1 / Figur 2  
figure 1 / figure 2

 Darstellung symbolisch  
symbolic drawing

**Fixierleisten / fixation rails**

Figur 1 / figure 1

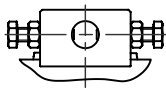

Leiste für Revolver  
mit Stift  
rail for turret with  
pin

Figur 2 / figure 2

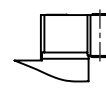
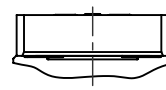

Leiste für Revolver  
ohne Stift  
rail for turret  
without pin

► Weitere Ausführungen auf Anfrage / further versions on request

Bestell-Nr. ref.-no.	Leiste / rail Figur ... / figure ...	Ø A [mm]	Ø B [mm]	c [mm]	d [mm]	e [mm]	f [mm]
8 239 27 012	1	25	30	110	85	60	35
8 239 27 014	2	25	30	110	85	60	35
8 239 28 010	1	32	30	110	85	60	35
8 239 28 012	2	32	30	110	85	60	35
8 239 27 013	1	25	30	125	100	60	35
8 239 27 015	2	25	30	125	100	60	35
8 239 28 011	1	32	30	125	100	60	35
8 239 28 013	2	32	30	125	100	60	35

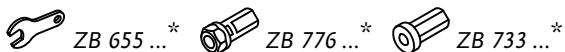

► Weitere Ausführungen auf Anfrage / further versions on request

\* Nicht im Lieferumfang enthalten  
\* not included in delivery



# Spannzangenhalter

## collet chuck holder

- ▶ Werkzeugaufnahme: Spannzangenaufnahme (DIN 6499)  
tool adaption: collet chuck (DIN 6499)

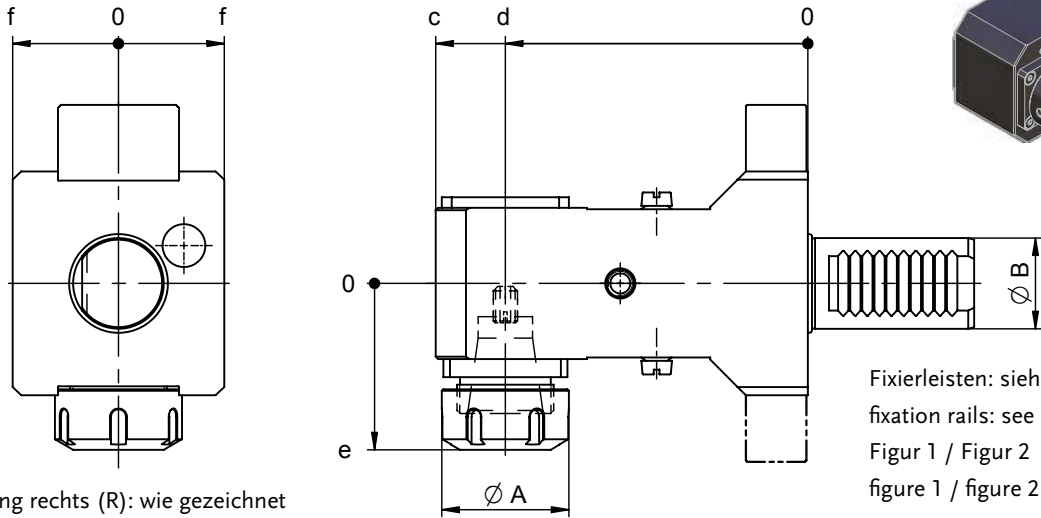
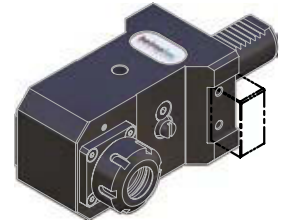

Fixierleisten: siehe  
fixation rails: see  
Figur 1 / Figur 2  
figure 1 / figure 2

- ▶ Ausführung rechts (R): wie gezeichnet  
right-hand version (R): as drawn
- ▶ Ausführung links (L): spiegelbildlich  
left-hand version (L): reversed-image

Darstellung symbolisch  
symbolic drawing

Fixierleisten / fixation rails	
 Figur 1 / figure 1 Leiste für Revolver mit Stift rail for turret with pin	 Figur 2 / figure 2 Leiste für Revolver ohne Stift rail for turret without pin

- ▶ Weitere Ausführungen auf Anfrage / further versions on request

Bestell-Nr. ref.-no.		Leiste / rail Figur ... / figure ...	Werkzeugaufnahme tool adaption	ø A [mm]	ø B [mm]	c [mm]	d [mm]	e [mm]	f [mm]
8 230 25 005	R	1	DIN 6499 - ER 25	42	30	108	85	55	35
8 230 25 018	R	2	DIN 6499 - ER 25	42	30	108	85	55	35
8 231 25 007	L	1	DIN 6499 - ER 25	42	30	108	85	55	35
8 231 25 008	L	2	DIN 6499 - ER 25	42	30	108	85	55	35
8 230 26 008	R	1	DIN 6499 - ER 32	50	30	108	85	65	35
8 230 26 028	R	2	DIN 6499 - ER 32	50	30	108	85	65	35
8 231 26 001	L	1	DIN 6499 - ER 32	50	30	108	85	65	35
8 231 26 014	L	2	DIN 6499 - ER 32	50	30	108	85	65	35
8 230 25 007	R	1	DIN 6499 - ER 25	42	30	123	100	55	35
8 230 25 019	R	2	DIN 6499 - ER 25	42	30	123	100	55	35
8 231 25 000	L	1	DIN 6499 - ER 25	42	30	123	100	55	35
8 231 25 009	L	2	DIN 6499 - ER 25	42	30	123	100	55	35
8 230 26 009	R	1	DIN 6499 - ER 32	50	30	123	100	65	35
8 230 26 029	R	2	DIN 6499 - ER 32	50	30	123	100	65	35
8 231 26 000	L	1	DIN 6499 - ER 32	50	30	123	100	65	35
8 231 26 015	L	2	DIN 6499 - ER 32	50	30	123	100	65	35



\* Nicht im Lieferumfang enthalten  
\* not included in delivery

- ▶ Weitere Ausführungen auf Anfrage / further versions on request

- ▶ Werkzeugaufnahme: Spannzangenaufnahme (DIN 6499)  
tool adaption: collet chuck (DIN 6499)

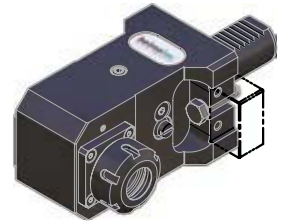
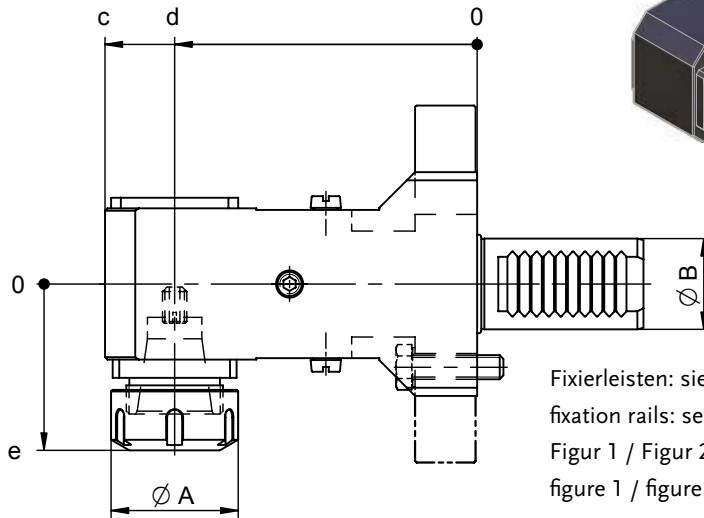
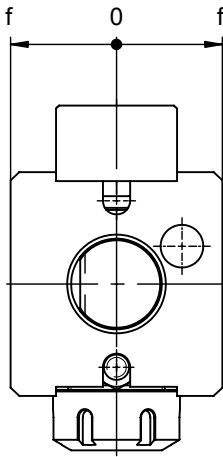

Fixierleisten: siehe  
fixation rails: see  
Figur 1 / Figur 2  
figure 1 / figure 2

- ▶ Ausführung rechts (R): wie gezeichnet  
right-hand version (R): as drawn
- ▶ Ausführung links (L): spiegelbildlich  
left-hand version (L): reversed-image

 Darstellung symbolisch  
symbolic drawing

### Fixierleisten / fixation rails

Figur 1 / figure 1

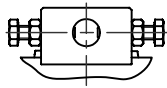

Leiste für Revolver  
mit Stift  
rail for turret with  
pin

Figur 2 / figure 2

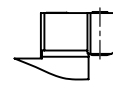
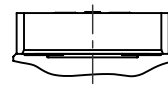
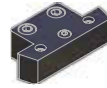

Leiste für Revolver  
ohne Stift  
rail for turret  
without pin

- ▶ Weitere Ausführungen auf Anfrage / further versions on request

Bestell-Nr. ref.-no.		Leiste / rail Figur ... / figure ...	Werkzeugaufnahme tool adaption	Ø A [mm]	Ø B [mm]	c [mm]	d [mm]	e [mm]	f [mm]
8 230 25 020	R	1	DIN 6499 - ER 25	42	30	108	85	55	35
8 230 25 022	R	2	DIN 6499 - ER 25	42	30	108	85	55	35
8 231 25 010	L	1	DIN 6499 - ER 25	42	30	108	85	55	35
8 231 25 012	L	2	DIN 6499 - ER 25	42	30	108	85	55	35
8 230 26 033	R	1	DIN 6499 - ER 32	50	30	108	85	65	35
8 230 26 035	R	2	DIN 6499 - ER 32	50	30	108	85	65	35
8 231 26 019	L	1	DIN 6499 - ER 32	50	30	108	85	65	35
8 231 26 021	L	2	DIN 6499 - ER 32	50	30	108	85	65	35
8 230 25 021	R	1	DIN 6499 - ER 25	42	30	123	100	55	35
8 230 25 023	R	2	DIN 6499 - ER 25	42	30	123	100	55	35
8 231 25 011	L	1	DIN 6499 - ER 25	42	30	123	100	55	35
8 231 25 013	L	2	DIN 6499 - ER 25	42	30	123	100	55	35
8 230 26 034	R	1	DIN 6499 - ER 32	50	30	123	100	65	35
8 230 26 036	R	2	DIN 6499 - ER 32	50	30	123	100	65	35
8 231 26 020	L	1	DIN 6499 - ER 32	50	30	123	100	65	35
8 231 26 022	L	2	DIN 6499 - ER 32	50	30	123	100	65	35

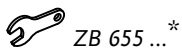

ZB 655 ...\*



ZB ER ...\*



ZB ET ...\*



ZB GB ...\*



ZB 741 ...\*

- \* Nicht im Lieferumfang enthalten  
\* not included in delivery

- ▶ Weitere Ausführungen auf Anfrage / further versions on request

# Doppel- Spannzangenhalter

## double collet chuck holder

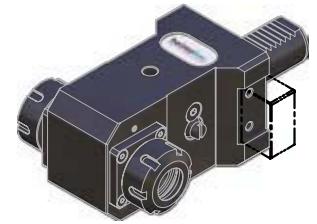
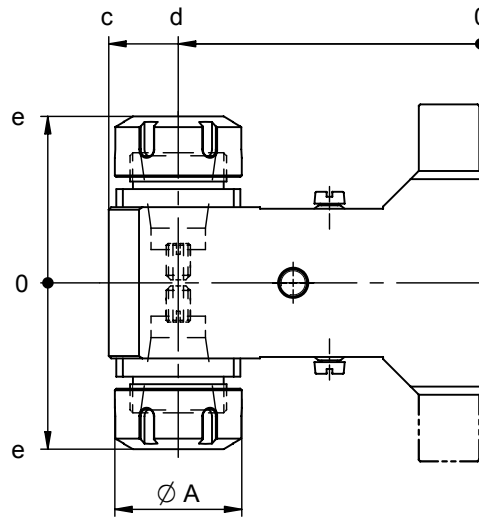
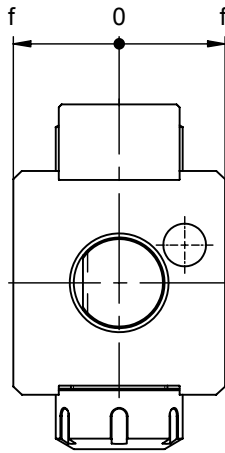

- ▶ Werkzeugaufnahme: Spannzangenaufnahme (DIN 6499)  
tool adaption: collet chuck (DIN 6499)



Fixierleisten: siehe  
fixation rails: see  
Figur 1 / Figur 2  
figure 1 / figure 2

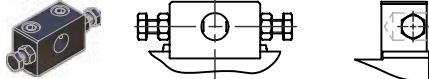

Darstellung symbolisch  
symbolic drawing

Fixierleisten / fixation rails	
 <p>Figur 1 / figure 1</p> <p>Leiste für Revolver mit Stift rail for turret with pin</p>	 <p>Figur 2 / figure 2</p> <p>Leiste für Revolver ohne Stift rail for turret without pin</p>

- ▶ Weitere Ausführungen auf Anfrage / further versions on request

Bestell-Nr. ref.-no.	Leiste / rail Figur ... / figure ...	Werkzeugaufnahme tool adaption	ø A [mm]	ø B [mm]	c [mm]	d [mm]	e [mm]	f [mm]
8 239 25 014	1	DIN 6499 - ER 25	42	30	108	85	55	35
8 239 25 017	2	DIN 6499 - ER 25	42	30	108	85	55	35
8 239 26 006	1	DIN 6499 - ER 32	50	30	108	85	65	35
8 239 26 014	2	DIN 6499 - ER 32	50	30	108	85	65	35
8 239 25 016	1	DIN 6499 - ER 25	42	30	123	100	55	35
8 239 25 018	2	DIN 6499 - ER 25	42	30	123	100	55	35
8 239 26 007	1	DIN 6499 - ER 32	50	30	123	100	65	35
8 239 26 015	2	DIN 6499 - ER 32	50	30	123	100	65	35



- ▶ Weitere Ausführungen auf Anfrage / further versions on request

\* Nicht im Lieferumfang enthalten  
\* not included in delivery

- ▶ Werkzeugaufnahme: Spannzangenaufnahme (DIN 6499)  
tool adaption: collet chuck (DIN 6499)

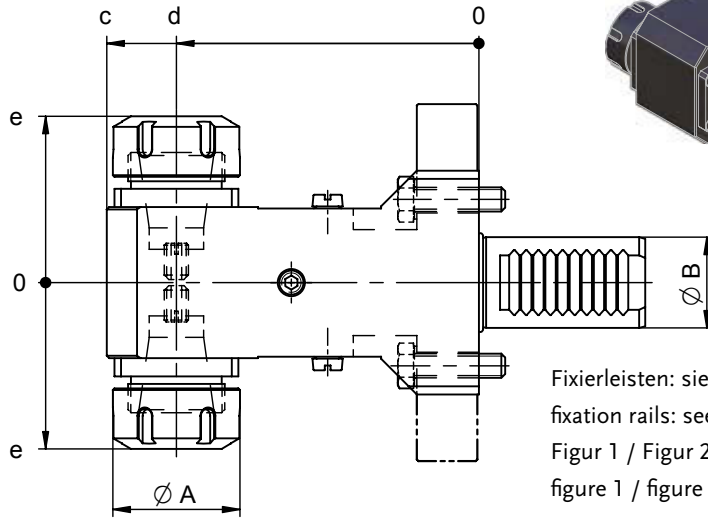
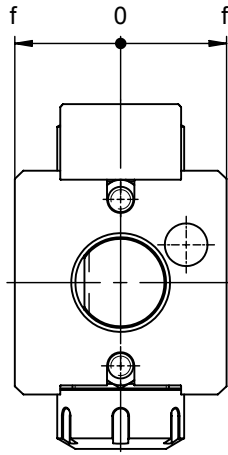

Fixierleisten: siehe  
fixation rails: see  
Figur 1 / Figur 2  
figure 1 / figure 2

 Darstellung symbolisch  
symbolic drawing

**Fixierleisten / fixation rails**

Figur 1 / figure 1

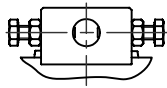

Leiste für Revolver  
mit Stift  
rail for turret with  
pin

Figur 2 / figure 2

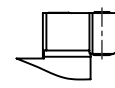
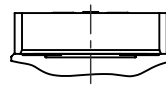
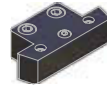

Leiste für Revolver  
ohne Stift  
rail for turret  
without pin

- ▶ Weitere Ausführungen auf Anfrage / further versions on request

Bestell-Nr. ref.-no.	Leiste / rail Figur ... / figure ...	Werkzeugaufnahme tool adaption	ø A [mm]	ø B [mm]	c [mm]	d [mm]	e [mm]	f [mm]
8 239 25 019	1	DIN 6499 - ER 25	42	30	108	85	55	35
8 239 25 021	2	DIN 6499 - ER 25	42	30	108	85	55	35
8 239 26 019	1	DIN 6499 - ER 32	50	30	108	85	65	35
8 239 26 021	2	DIN 6499 - ER 32	50	30	108	85	65	35
8 239 25 020	1	DIN 6499 - ER 25	42	30	123	100	55	35
8 239 25 022	2	DIN 6499 - ER 25	42	30	123	100	55	35
8 239 26 020	1	DIN 6499 - ER 32	50	30	123	100	65	35
8 239 26 022	2	DIN 6499 - ER 32	50	30	123	100	65	35



ZB 655 ...\*



ZB ER ...\*



ZB ET ...\*



ZB GB ...\*



ZB 741 ...\*

- ▶ Weitere Ausführungen auf Anfrage / further versions on request

\* Nicht im Lieferumfang enthalten  
\* not included in delivery

# Aufnahmehalter tool holder

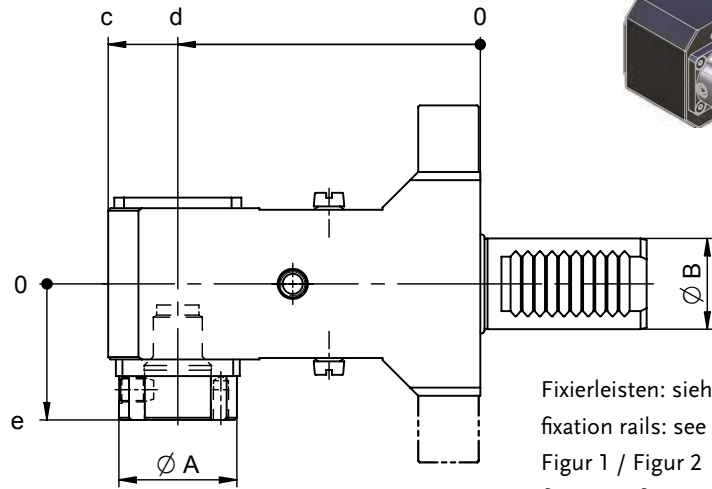
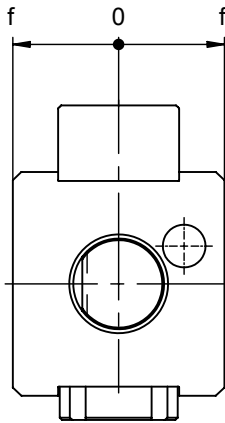

- ▶ Werkzeugaufnahme: *easy-quick*  
tool adaption: *easy-quick*



Fixierleisten: siehe  
fixation rails: see  
Figur 1 / Figur 2  
figure 1 / figure 2

- ▶ Ausführung rechts (R): wie gezeichnet  
right-hand version (R): as drawn
- ▶ Ausführung links (L): spiegelbildlich  
left-hand version (L): reversed-image

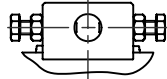
 Darstellung symbolisch  
symbolic drawing

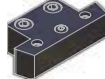
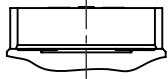
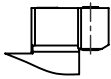
Fixierleisten / fixation rails	
Figur 1 / figure 1	Figur 2 / figure 2
   <p>Leiste für Revolver mit Stift rail for turret with pin</p>	   <p>Leiste für Revolver ohne Stift rail for turret without pin</p>

- ▶ Weitere Ausführungen auf Anfrage / further versions on request

Bestell-Nr. ref.-no.	Leiste / rail Figur ... / figure ...	Werkzeugaufnahme tool adaption	Ø A [mm]	Ø B [mm]	c [mm]	d [mm]	e [mm]	f [mm]
8 230 26 030	R 1	<i>easy-quick</i> HT 4	39	30	108	85	45	35
8 230 26 031	R 2	<i>easy-quick</i> HT 4	39	30	108	85	45	35
8 231 26 016	L 1	<i>easy-quick</i> HT 4	39	30	108	85	45	35
8 231 26 017	L 2	<i>easy-quick</i> HT 4	39	30	108	85	45	35
8 230 26 023	R 1	<i>easy-quick</i> HT 4	39	30	123	100	45	35
8 230 26 032	R 2	<i>easy-quick</i> HT 4	39	30	123	100	45	35
8 231 26 011	L 1	<i>easy-quick</i> HT 4	39	30	123	100	45	35
8 231 26 018	L 2	<i>easy-quick</i> HT 4	39	30	123	100	45	35

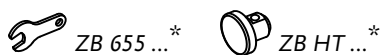

- ▶ Weitere Ausführungen auf Anfrage / further versions on request

\* Nicht im Lieferumfang enthalten  
\* not included in delivery

- ▶ Werkzeugaufnahme: *easy-quick*  
tool adaption: *easy-quick*

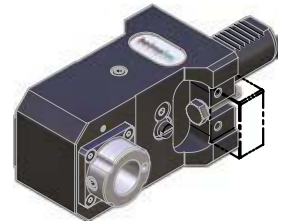
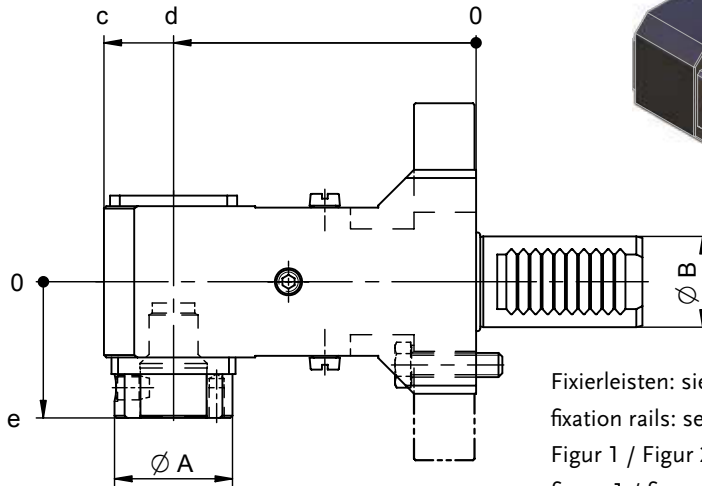
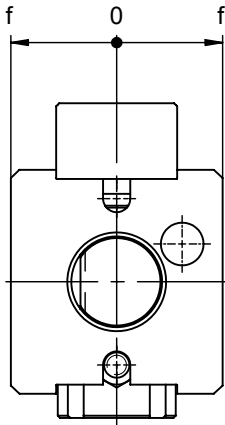

Fixierleisten: siehe  
fixation rails: see  
Figur 1 / Figur 2  
figure 1 / figure 2

- ▶ Ausführung rechts (R): wie gezeichnet  
right-hand version (R): as drawn
- ▶ Ausführung links (L): spiegelbildlich  
left-hand version (L): reversed-image

 Darstellung symbolisch  
symbolic drawing

**Fixierleisten / fixation rails**

Figur 1 / figure 1

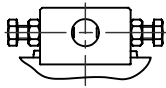

Leiste für Revolver  
mit Stift  
rail for turret with  
pin

Figur 2 / figure 2

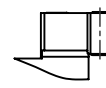
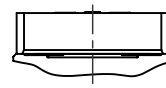
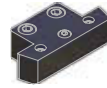

Leiste für Revolver  
ohne Stift  
rail for turret  
without pin

- ▶ Weitere Ausführungen auf Anfrage / further versions on request

Bestell-Nr. ref.-no.		Leiste / rail Figur ... / figure ...	Werkzeugaufnahme tool adaption	Ø A [mm]	Ø B [mm]	c [mm]	d [mm]	e [mm]	f [mm]
8 230 26 037	R	1	<i>easy-quick</i> HT 4	39	30	108	85	45	35
8 230 26 039	R	2	<i>easy-quick</i> HT 4	39	30	108	85	45	35
8 231 26 023	L	1	<i>easy-quick</i> HT 4	39	30	108	85	45	35
8 231 26 025	L	2	<i>easy-quick</i> HT 4	39	30	108	85	45	35
8 230 26 038	R	1	<i>easy-quick</i> HT 4	39	30	123	100	45	35
8 230 26 040	R	2	<i>easy-quick</i> HT 4	39	30	123	100	45	35
8 231 26 024	L	1	<i>easy-quick</i> HT 4	39	30	123	100	45	35
8 231 26 026	L	2	<i>easy-quick</i> HT 4	39	30	123	100	45	35

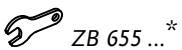

ZB 655 ...\*



ZB HT ...\*

- ▶ Weitere Ausführungen auf Anfrage / further versions on request

\* Nicht im Lieferumfang enthalten  
\* not included in delivery

# Doppel- Aufnahmehalter

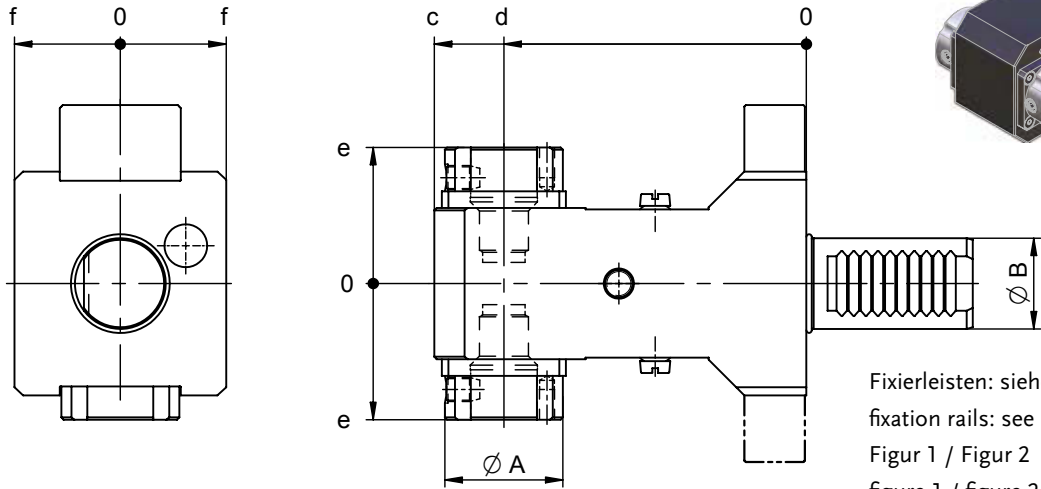

## double tool holder

- ▶ Werkzeugaufnahme: *easy-quick*  
tool adaption: *easy-quick*



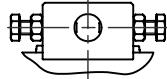

Fixierleisten: siehe  
fixation rails: see  
Figur 1 / Figur 2  
figure 1 / figure 2

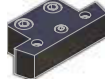
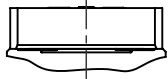
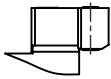
 Darstellung symbolisch  
symbolic drawing

Fixierleisten / fixation rails		
<i>Figur 1 / figure 1</i>		
		 Leiste für Revolver mit Stift rail for turret with pin
<i>Figur 2 / figure 2</i>		
		 Leiste für Revolver ohne Stift rail for turret without pin

- ▶ Weitere Ausführungen auf Anfrage / further versions on request

Bestell-Nr. ref.-no.	Leiste / rail Figur ... / figure ...	Werkzeugaufnahme tool adaption	ø A [mm]	ø B [mm]	c [mm]	d [mm]	e [mm]	f [mm]
8 239 26 017	1	<i>easy-quick</i> HT 4	39	30	108	85	45	35
8 239 26 018	2	<i>easy-quick</i> HT 4	39	30	108	85	45	35
8 239 26 013	1	<i>easy-quick</i> HT 4	39	30	123	100	45	35
8 239 26 016	2	<i>easy-quick</i> HT 4	39	30	123	100	45	35

 ZB 655 ...\*     ZB HT ...\*

- ▶ Weitere Ausführungen auf Anfrage / further versions on request

\* Nicht im Lieferumfang enthalten  
\* not included in delivery

- ▶ Werkzeugaufnahme: *easy-quick*  
tool adaption: *easy-quick*

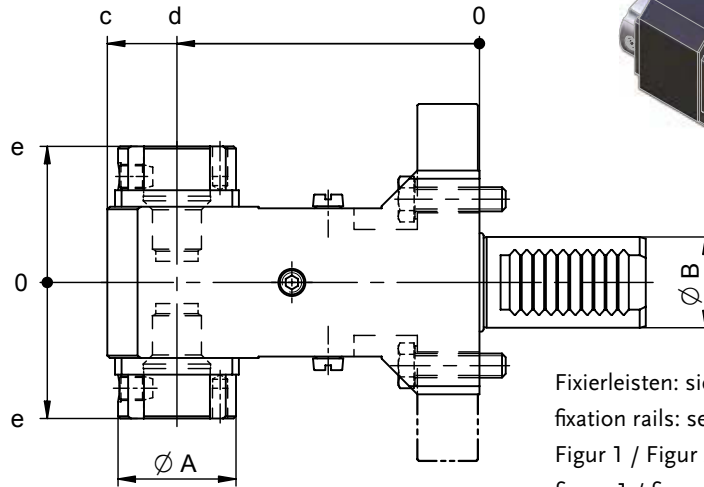
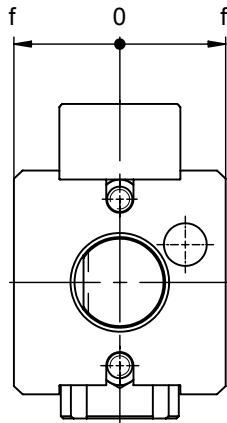

Fixierleisten: siehe  
fixation rails: see  
Figur 1 / Figur 2  
figure 1 / figure 2

 Darstellung symbolisch  
symbolic drawing

### Fixierleisten / fixation rails

Figur 1 / figure 1

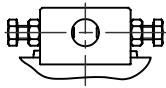

Leiste für Revolver  
mit Stift  
rail for turret with  
pin

Figur 2 / figure 2

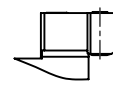
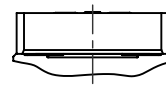
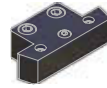

Leiste für Revolver  
ohne Stift  
rail for turret  
without pin

- ▶ Weitere Ausführungen auf Anfrage / further versions on request

Bestell-Nr. ref.-no.	Leiste / rail Figur ... / figure ...	Werkzeugaufnahme tool adaption	ø A [mm]	ø B [mm]	c [mm]	d [mm]	e [mm]	f [mm]
8 239 26 023	1	<i>easy-quick</i> HT 4	39	30	108	85	45	35
8 239 26 025	2	<i>easy-quick</i> HT 4	39	30	108	85	45	35
8 239 26 024	1	<i>easy-quick</i> HT 4	39	30	123	100	45	35
8 239 26 026	2	<i>easy-quick</i> HT 4	39	30	123	100	45	35

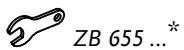

ZB 655 ...\*



ZB HT ...\*

- ▶ Weitere Ausführungen auf Anfrage / further versions on request

\* Nicht im Lieferumfang enthalten  
\* not included in delivery



# Abstechhalter höhenverstellbar

## cut-off holder, height adjustable

- ▶ Werkzeugaufnahme: Schwerhöhe SH  
tool adaption: height of parting blade SH

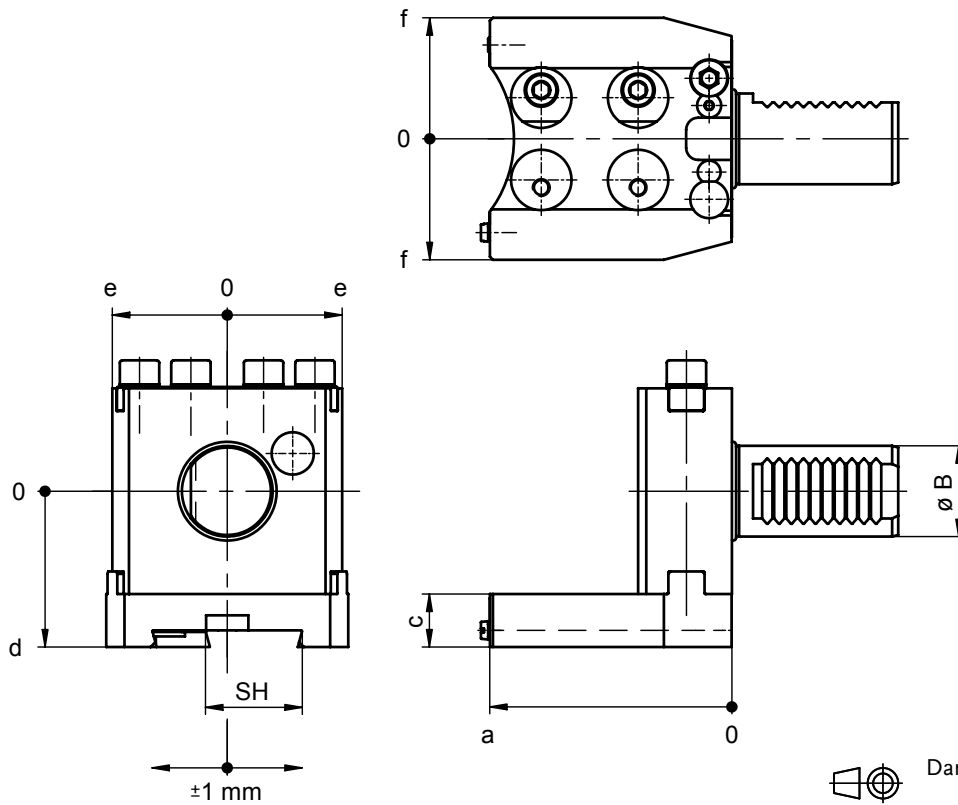

Bestell-Nr. ref.-no.	SH	a [mm]	ø B [mm]	c [mm]	d [mm]	e [mm]	f [mm]
8 320 22 007	26	75	30	15	50	38	35
8 320 23 005	32	80	30	17,5	51,5	38	40

ZB 655 ...\*

- ▶ Universelle Einsatzmöglichkeiten  
universal application types

**1 Halter = 4 Varianten**  
**1 holder = 4 versions**

Stechschwert nicht im Lieferumfang enthalten  
cut-off tool not included in delivery

Variante 1  
version 1



Variante 2  
version 2



Variante 3  
version 3

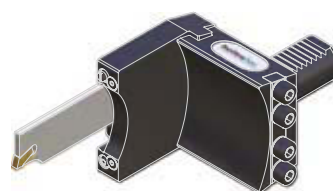

Variante 4  
version 4



- \* Nicht im Lieferumfang enthalten
- \* not included in delivery

- ▶ Weitere Ausführungen auf Anfrage / further versions on request

- ▶ Werkzeugaufnahme: DIN 69880  
tool adaption: DIN 69880

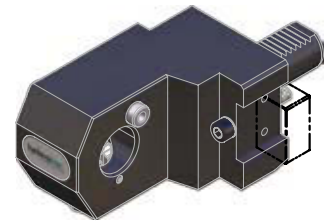
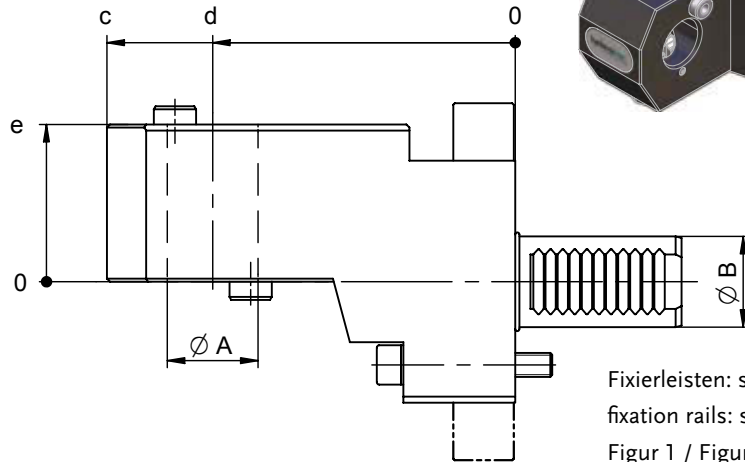
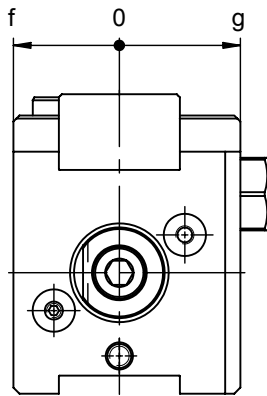

Fixierleisten: siehe  
fixation rails: see  
Figur 1 / Figur 2  
figure 1 / figure 2

- ▶ Ausführung rechts (R): wie gezeichnet  
right-hand version (R): as drawn
- ▶ Ausführung links (L): spiegelbildlich  
left-hand version (L): reversed-image

 Darstellung symbolisch  
symbolic drawing

### Fixierleisten / fixation rails

Figur 1 / figure 1

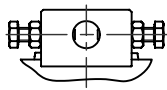

Leiste für Revolver  
mit Stift  
rail for turret with  
pin

Figur 2 / figure 2

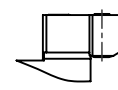
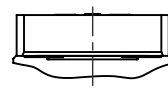

Leiste für Revolver  
ohne Stift  
rail for turret  
without pin

- ▶ Weitere Ausführungen auf Anfrage / further versions on request

Bestell-Nr. ref.-no.		Leiste / rail Figur ... / figure ...	Ø A [mm]	Ø B [mm]	c [mm]	d [mm]	e [mm]	f [mm]	g [mm]
8 209 22 000	R	1	30	30	120	85	52	35	40
8 209 22 019	R	2	30	30	120	85	52	35	40
8 209 22 006	L	1	30	30	120	85	52	35	40
8 209 22 020	L	2	30	30	120	85	52	35	40
8 209 22 011	R	1	30	30	135	100	52	35	40
8 209 22 021	R	2	30	30	135	100	52	35	40
8 209 22 007	L	1	30	30	135	100	52	35	40
8 209 22 022	L	2	30	30	135	100	52	35	40

 ZB 655 ...\*

- ▶ Weitere Ausführungen auf Anfrage / further versions on request

\* Nicht im Lieferumfang enthalten  
\* not included in delivery

# Kombi- Plandrehhalter

## combi facing holder

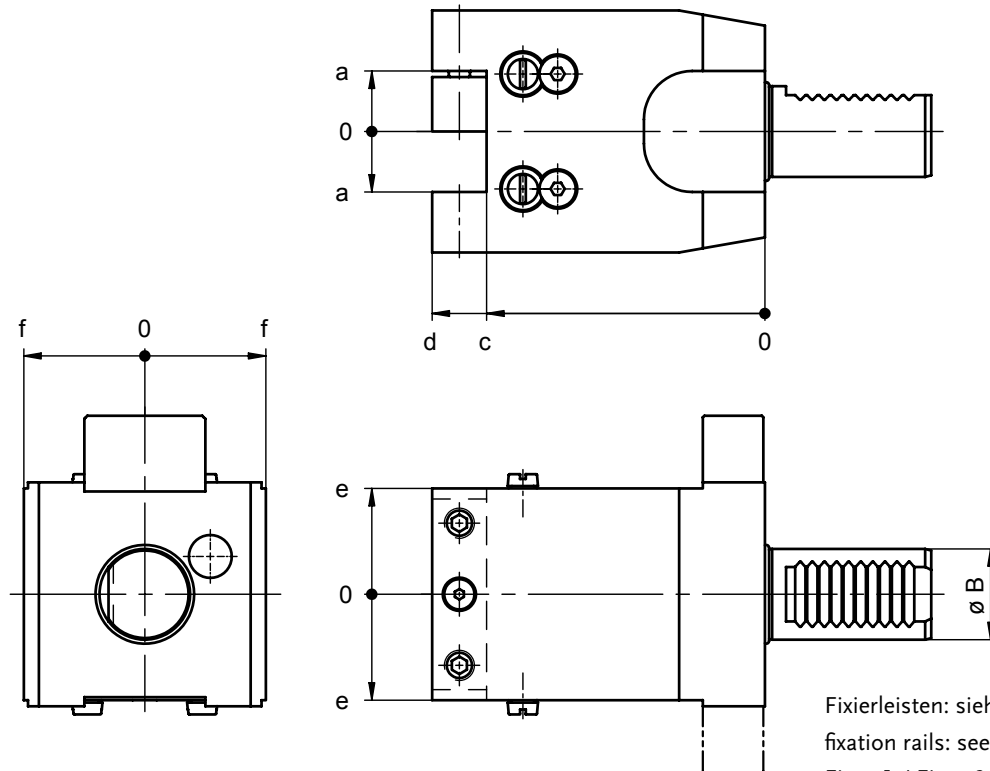
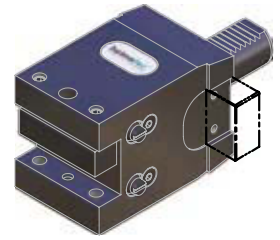

Fixierleisten: siehe  
fixation rails: see  
Figur 1 / Figur 2  
figure 1 / figure 2



Darstellung symbolisch  
symbolic drawing

Fixierleisten / fixation rails	
<p><i>Figur 1 / figure 1</i></p> <p>Leiste für Revolver mit Stift rail for turret with pin</p>	<p><i>Figur 2 / figure 2</i></p> <p>Leiste für Revolver ohne Stift rail for turret without pin</p>

► Weitere Ausführungen auf Anfrage / further versions on request

Bestell-Nr. ref.-no.	Leiste / rail Figur ... / figure ...	a [mm]	Ø B [mm]	c [mm]	d [mm]	e [mm]	f [mm]
8 234 24 003	1	20	30	92	110	35	40
8 234 24 002	2	20	30	92	110	35	40

ZB 655 ...\*

► Weitere Ausführungen auf Anfrage / further versions on request

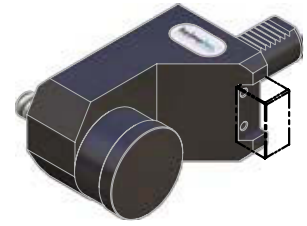
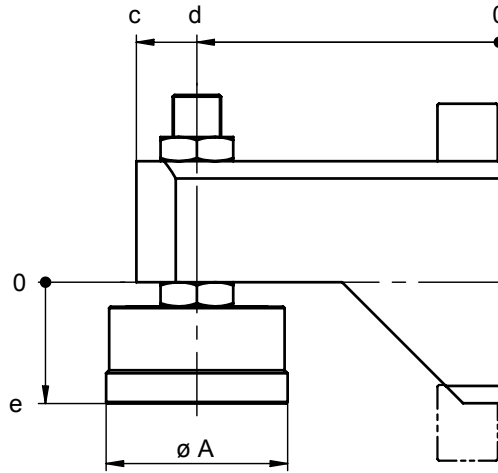
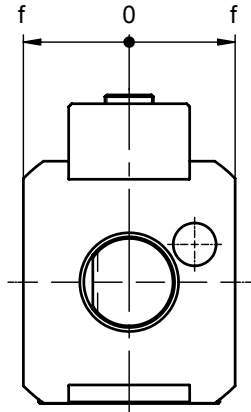

\* Nicht im Lieferumfang enthalten  
\* not included in delivery



- ▶ Ausführung rechts (R): wie gezeichnet  
right-hand version (R): as drawn
- ▶ Ausführung links (L): spiegelbildlich  
left-hand version (L): reversed-image

 Darstellung symbolisch  
symbolic drawing

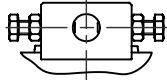
Fixierleisten: siehe  
fixation rails: see  
Figur 1 / Figur 2  
figure 1 / figure 2

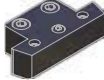
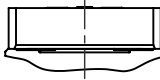
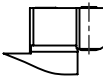
Fixierleisten / fixation rails	
Figur 1 / figure 1	Figur 2 / figure 2
   <p>Leiste für Revolver mit Stift rail for turret with pin</p>	   <p>Leiste für Revolver ohne Stift rail for turret without pin</p>

- ▶ Weitere Ausführungen auf Anfrage / further versions on request

Bestell-Nr. ref.-no.	Leiste / rail Figur ... / figure ...	ø A [mm]	ø B [mm]	c [mm]	d [mm]	e [mm]		f [mm]
						min.	max.	
8 262 29 011	R 1	60	30	120	85	40	75	35
8 262 29 019	R 2	60	30	120	85	40	75	35
8 262 29 012	L 1	60	30	120	85	40	75	35
8 262 29 020	L 2	60	30	120	85	40	75	35
8 262 29 010	R 1	60	30	120	100	40	75	35
8 262 29 021	R 2	60	30	120	100	40	75	35
8 262 29 009	L 1	60	30	120	100	40	75	35
8 262 29 022	L 2	60	30	120	100	40	75	35

 ZB 655 ...\*

- ▶ Weitere Ausführungen auf Anfrage / further versions on request

\* Nicht im Lieferumfang enthalten  
\* not included in delivery

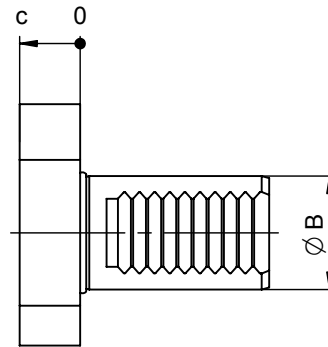
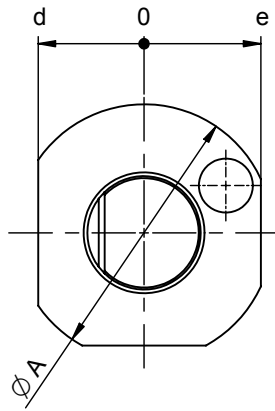
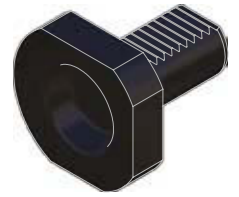











Darstellung symbolisch  
symbolic drawing

Bestell-Nr. ref.-no.	$\varnothing A$ [mm]	$\varnothing B$ [mm]	c [mm]	d [mm]	e [mm]
8 200 20 011	68	30	16	27	31

► Weitere Ausführungen auf Anfrage / further versions on request

\* Nicht im Lieferumfang enthalten  
\* not included in delivery



Symbole symbols	Zubehörblatt accessory sheet
 ZB 655 ...*	Bedienwerkzeuge service tools
 ZB ER ...*	Spannzangen ER-DIN 6499 collets ER-DIN 6499
 ZB ET ...*	Gewindebohrzangen ET-DIN 6499 tapping collets ET-DIN 6499
 ZB GB ...*	Gewindebohrzangen GB tapping collets GB
 ZB 741 ...*	Dichtscheiben Sealing discs
 ZB 620 ...*	Fräsdornringe milling arbor spacers
 ZB HT ...*	<i>easy-quick</i>
 ZB UT ...*	u-tec
 ZB 776 ...*	Spannzangenfutter collet chuck
 ZB 73. ...*	Reduzierbuchsen reducing sleeves

► Weitere Ausführungen auf Anfrage  
further versions on request



Darstellung symbolisch  
symbolic drawing

\* Nicht im Lieferumfang enthalten  
\* not included in delivery

