

frezy

end mills
фрезы

frezy walcowo-czołowe
end mills
цилиндрическо-торцевые фрезы

frezy walcowe
cylindrical end mills
стержневые фрезы для матриц

frezy stożkowe
tapered end mills
конические фрезы для матриц

frezy krążkowe
involute gear cutters
дискосые фрезы



Pobierz ten dział katalogu w wersji elektronicznej.
Download this part of catalogue.
Скачать эту часть каталога в электронной версии.

Frezy / Milling cutters / Фрезы

Grupa
Group
Группа

Materiał cz. skrawającej
Cutting part material
Материал режущей части

norma
standard
норма

str.
p./c.

Frezy trzpieniowe do rowków na wpusty z chwytem stożkowym Morse'a

Slot drills, helical flute with Morse taper shank

Стержневые фрезы винтовые для шпоночных пазов с коническим хвостовиком Морзе



N

HSS

HSS-E

DIN 326-D 47

Frezy trzpieniowe do rowków na wpusty z chwytem walcowym

Slot drills, helical flute with straight shank

Стержневые фрезы винтовые для шпоночных пазов с цилиндрическим хвостом



N

HSS

HSS-E

PM
HSS-E

DIN 327-(B,D) K 48

Frezy trzpieniowe z czołem kulistym z chwytem walcowym

Ball nosed slot drills, helical flute with straight shank

Стержневые фрезы винтовые для шпоночных пазов с цилиндрическим хвостом



N

HSS

HSS-E

DIN 327-(B,D) KR 49

Frezy trzpieniowe walcowo-czołowe, krótkie uniwersalne z chwytem walcowym

End mills, short universal with straight shank

Стержневые фрезы цилиндрическо-торцевые универсальные с цилиндрическим хвостом



N

HSS

HSS-E

PM
HSS-E

DIN 844-(A,B) K-N 50

Frezy trzpieniowe walcowo-czołowe, krótkie o ostrzach centralnych z chwytem walcowym

End mills, short center-cutting with straight shank

Стержневые фрезы цилиндрическо-торцевые короткие с центральными лезвиями с цилиндрическим хвостом



N

HSS

HSS-E

PM
HSS-E

DIN 844-(A,B) K-M-N 51

Frezy trzpieniowe walcowo-czołowe, długie uniwersalne z chwytem walcowym

End mills, long universal with straight shank

Стержневые фрезы цилиндрическо-торцевые длинные универсальные с цилиндрическим хвостом



N

HSS

HSS-E

PM
HSS-E

DIN 844-(A,B) L-N 52

Frezy trzpieniowe walcowo-czołowe, długie o ostrzach centralnych z chwytem walcowym

End mills, long center-cutting with straight shank

Стержневые фрезы цилиндрическо-торцевые длинные с центральными лезвиями с цилиндрическим хвостом



N

HSS

HSS-E

PM
HSS-E

DIN 844-(A,B) L-M-N 53

Frezy trzpieniowe walcowo-czołowe, krótkie uniwersalne z chwytem stożkowym Morse'a

End mills, short universal with Morse taper shank

Стержневые фрезы цилиндрическо-торцевые короткие универсальные с коническим хвостовиком Морзе



N

HSS

HSS-E

DIN 845-B K-N 54

Frezy trzpieniowe walcowo-czołowe, długie uniwersalne z chwytem stożkowym Morse'a

End mills, long universal with Morse taper shank

Стержневые фрезы цилиндрическо-торцевые длинные универсальные с коническим хвостовиком Морзе



N

HSS

HSS-E

DIN 845-B L-N 55

Frezy walcowo-czołowe, nasadzone z zabierakiem czołowym

Shell end mills with keyslot

Фрезы цилиндрическо-торцевые, насадные с торцевым поводком



N

NR

W

HSS

HSS-E

DIN 1880 56

Frezy modułowe krążkowe do kół zębatach o zarysie ewolwentowym (m = 0,5÷7 kpl. 8-sztukowe)

Involute gear cutters (m = 0,5÷7 8 pcs in set)

Модульные дисковые фрезы для шестерни револьверного профиля (m = 0,5÷7 кмп. 8-штуковые)



N

HSS

NFMa 57

Frezy modułowe krążkowe do kół zębatach o zarysie ewolwentowym (m = 8)

Involute gear cutters (m = 8 pcs)

Модульные дисковые фрезы для шестерни револьверного профиля (m = 8)



N

HSS

NFmb 58

	Grupa Group Группа	Materiał cz. skrawającej Cutting part material Материал режущей части	norma standard норма	str. p./c.
Frezy krążkowe do kół łańcuchowych Roller chain sprocket milling cutters Дисковые фрезы для цепных колёс	N	HSS	NFMI	58
Frezy trzpieniowe do rowków na wpusty, długie z chwytem walcowym Slot drills, helical flute, long with straight shank Стержневые фрезы винтовые для шпоночных пазов, длинные с цилиндрическим хвостом	N	HSS	NFI	59
Frezy trzpieniowe z chwytem walcowym do usuwania zgrzewów punktowych End mills with straight shank for spot welds removing Стержневые фрезы с цилиндрическим хвостом для удаления пунтктовых швов	N	HSS-E	NFPz	59
Frezy trzpieniowe walcowo-czołowe, krótkie do obróbki zgrubnej z chwytem walcowym Roughing end mills, short with straight shank Стержневые фрезы цилиндрическо-торцевые, короткие для черновой обработки с цилиндрическим хвостом	NR	HSS-E	DIN 844-(A,B) K-NR DIN 844-(A,B) K-M-NR	60
Frezy trzpieniowe walcowo-czołowe, długie do obróbki zgrubnej z chwytem walcowym Roughing end mills, long with straight shank Стержневые фрезы цилиндрическо-торцевые, длинные для черновой обработки с цилиндрическим хвостом	NR	HSS-E	DIN 844-(A,B) L-NR DIN 844-(A,B) L-M-NR	61
Frezy trzpieniowe walcowo-czołowe, krótkie do obróbki zgrubnej z chwytem stożkowym Morse'a Roughing end mills, short with Morse taper shank Стержневые фрезы цилиндрическо-торцевые, короткие для черновой обработки с коническим хвостовиком Морзе	NR	HSS-E	DIN 845-B K-NR DIN 845-B K-M-NR	62
Frezy trzpieniowe walcowo-czołowe, długie do obróbki zgrubnej z chwytem stożkowym Morse'a Roughing end mills, long with Morse taper shank Стержневые фрезы цилиндрическо-торцевые, длинные для черновой обработки с коническим хвостовиком Морзе	NR	HSS-E	DIN 845-B L-NR DIN 845-B L-M-NR	63
Frezy trzpieniowe walcowo-czołowe, krótkie i długie o ostrzach centralnych z chwytem walcowym End mills, short and long center-cutting with straight shank Стержневые фрезы цилиндрическо-торцевые, короткие и длинные с центральными лезвиями с цилиндрическим хвостом	NH	HSS	DIN 844-(A,B) K&L-M-NH 50°	64
Frezy trzpieniowe walcowo-czołowe, krótkie i długie o ostrzach centralnych z chwytem walcowym End mills, short and long center-cutting with straight shank Стержневые фрезы цилиндрическо-торцевые, короткие и длинные с центральными лезвиями с цилиндрическим хвостом	W	HSS	DIN 844-(A,B) K&L-M-W	65
Frezy trzpieniowe jednoostrzowe do otworów odwadniających w stolarcze z PCV Fly cutters for dehydrating holes in the PVC work Стержневые фрезы с 1-лезвием для водоотводных отверстии в пластмассовых столярках	W	HSS	NFPo	66
Frezy trzpieniowe jednoostrzowe z czołem Drill Point 90° * Waterslot cutters with Drill Point 90° * Стержневые фрезы с одним лезвием и торцом Drill Point 90° *			NFPv	67
Frezy trzpieniowe jednoostrzowe do metali lekkich i tworzyw sztucznych - uniwersalne Fly cutters for light metals and plastics, universal Стержневые фрезы с 1-лезвием для легких металлов и пластмасс – универсальные	W	HSS-E	NFPj	67

Norma

Standard
Норма

DIN 844K narzędzie wykonane wg normy DIN 844
tool acc. to DIN 844
инструмент изготовлено согласно норме DIN 844

PN-89/M 58900 narzędzie wykonane wg normy PN-89/M-5890
tool acc. to PN-89/M-5890
инструмент изготовлено согласно норме PN-89/M-5890



narzędzie wykonane wg norm FENES S.A.
tool has been manufactured acc. to FENES S.A. standards
инструмент изготовлено согласно норме FENES S.A.

Czoła frezów [liczba ostrzy]

Faces of end mills [no. of teeth]
Торцы фрез [количество лезвий]



frez 1-ostrzowy
fly cutter
фреза с 1 лезвием



frez 2-ostrzowy z czołem płaskim
2-flute flat nosed end mill
фреза с 2- лезвиями с плоским торцом



frez 4-ostrzowy z czołem płaskim
4-flute flat nosed end mill
фреза с 4-лезвиями с плоским торцом



frez wieloostrowy z czołem płaskim
multi-flute flat nosed end mill
фреза многолезвенная с плоским торцом



frez wieloostrowy z ostrz. centralnymi symetrycznymi na czole
multi-flute, center-cutting symmetrical points
фреза многолезвенная с лезвиями центральными симметричными на торце



frez 2-ostrzowy z czołem kulistym
2-flute ball nosed end mill
фреза с 2- лезвиями с шаровым торцом



frez 3-ostrzowy z czołem płaskim
3-flute flat nosed end mill
фреза с 3-лезвиями с плоским торцом



frez 4-ostrzowy z czołem kulistym
4-flute ball nosed end mill
фреза с 4-лезвиями с шаровым торцом



frez wieloostrowy z czołem kulistym
multi-flute, ball nosed end mill
фреза многолезвенная с шаровым торцом



frez wieloostrowy z pogłębieniem na czole
multi-flute, spot faced end mill
фреза многолезвенная с углублением на торце

Geometria części skrawającej

Cutting part geometry
Геометрия режущей части



$\lambda \approx 25^\circ$ kąt pochylenia linii śrubowej rowków wiórowych
helix angle
угол наклона винтовой линии стружочных канавок



ostrze z zaszlifem po spirali
helical relief grinding flute
лезвие с зашлифом по спирали



**1:6
1:10
1:20** narzędzie stożkowe określone pochyleniem krawędzi skrawającej do osi narzędzia
tapered tool determined by cutting edge inclination to the tool axle
конический инструмент определённый наклоном режущей кромки к оси инструмента



kierunki pracy narzędzia
possible tool working movements
возможные рабочие движения инструмента



ostrze ścinowe
chisel edge blade
лезвие обрезное

Rodzaj chwytu [forma mocowania]

Shank [clamping method]

Вид хвоста [форма крепления]



chwyt wałc. gładki wg DIN 1835-A
straight shank, plane acc. to DIN 1835-A
цилиндрический хвост гладкий по DIN 1835-A



chwyt wałc. gładki DIN 6535-HA
plane straight shank, smooth acc. to DIN 6535-HA
хвост цилиндрический гладкий по DIN 6535-HA



chwyt stoż. Morse'a z nakiełkiem gwint. wg DIN 228-A
Morse taper shank (tapped) acc. to DIN 228-A
конический хвостовик Морзе с центровым гнездом согласно DIN 228-A



chwyt Weldona wg DIN 1835-B
Weldon shank acc. to DIN 1835-B
хвост Велдона по DIN 1835-B



chwyt Weldona wg DIN 6535-HB
Weldon shank acc. to DIN 6535-HB
хвост Вельдона по DIN 6535-HB



narzędzie nasadzone z zabier. czołowym wg DIN 138
shell tool with splined driver acc. to DIN 138
инструмент насадной с торцевым поводком согласно DIN 138

Materiał części skrawającej

Cutting part material

Материал режущей части



stal szybko tnącą standardowa
standard high speed steel
быстрорежущая сталь стандартная



stal proszkowa szybko tnąca z zawartością kobaltu
pulver cobalt high speed steel
порошковая быстрорежущая сталь с содержанием кобальта



stal szybko tnąca z zawartością kobaltu
cobalt high speed steel
быстрорежущая сталь с содержанием кобальта



narzędzia pełnowęglikowe
solid carbide tools
инструменты из твёрдых сплавов

Powłoki na części skrawającej

Coating on cutting part

Покрытие режущей части



TiN



AlTiN



TiAlN

Grupa

Group

Группа



ogólnego przeznaczenia
for general use
общего предназначения



do obróbki metali lekkich i tworzyw sztucznych
for machining of light metals and plastics
для обработки легких металлов и пластмасс



do obróbki materiałów trudnoskrawalnych o twardości ≤ 45 HRC
for machining of poor machinable materials up to 45 HRC
для обработки труднорезающихся материалов до 45 HRC



do obróbki materiałów o twardości ≤ 63 HRC
for machining of materials up to 63 HRC
для обработки материалов до 63 HRC

DIN 326-D

Frezy trzpieniowe do rowków na wpusty z chwytem stożkowym Morse'a

Slot drills, helical flute with Morse taper shank

Стержневые фрезы винтовые для шпоночных пазов с коническим хвостовиком Морзе

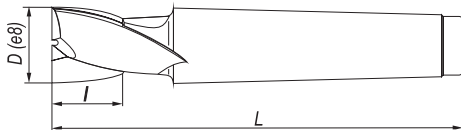

→ DIN 326 D

D	l	L	Nr stoż MT / H° конуса	HSS index 0641-552-	HSS Golden Line index 0641-556-	HSS-E index 0641-552-	HSS-E Golden Line index 0641-556-
10	13	83	1	-400-205	-400-205	-400-705	-400-705
12	16	86	1	-400-210	-400-210	-400-710	-400-710
14	16	101	2	-400-215	-400-215	-400-715	-400-715
16	19	104	2	-400-220	-400-220	-400-720	-400-720
18	19	104	2	-400-225	-400-225	-400-725	-400-725
20	22	107	2	-400-230	-400-230	-400-730	-400-730
22	22	107	2	-400-235	-400-235	-400-735	-400-735
24	26	128	3	-400-240	-400-240	-400-740	-400-740
25	26	128	3	-400-245	-400-245	-400-745	-400-745
28	26	128	3	-400-250	-400-250	-400-750	-400-750
30	26	128	3	-400-255	-400-255	-400-755	-400-755
32	32	131	3	-400-261	-400-261	-400-761	-400-761
32	32	157	4	-400-260	-400-260	-400-760	-400-760
36	32	157	4	-400-265	-400-265	-400-765	-400-765
38	38	163	4	-400-270	-400-270	-400-770	-400-770
40	38	163	4	-400-275	-400-275	-400-775	-400-775
45	38	163	4	-400-280	-400-280	-400-780	-400-780
50	45	293	5	-400-285	-400-285	-400-785	-400-785
56	45	203	5	-400-290	-400-290	-400-790	-400-790
63	53	211	5	-400-295	-400-295	-400-795	-400-795



Na specjalne zamówienie wykonujemy narzędzia o wymiarach innych niż zawarte w tabeli / For the special order we make tools of other dimensions than contained in table / По спец. заказу производим инструменты в размерах других, чем указанные в таблице

1.1

1.2

3.1

3.2

5.1

5.2

6

IV

N

DIN 327-(B,D) K

Frezy trzpieniowe do rowków na wpusty z chwytem walcowym

Slot drills, helical flute with straight shank

Стержневые фрезы винтовые для шпоночных пазов с цилиндрическим хвостом

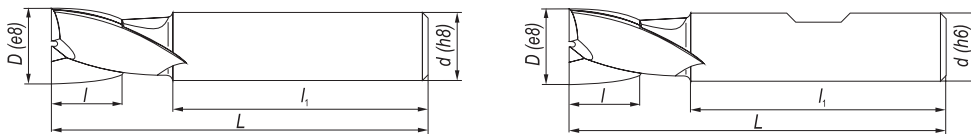

→ DIN 327-B K

D	d	l	l ₁	L	HSS	HSS Golden Line	HSS-E	HSS-E Golden Line	PM HSS-E	PM HSS-E TiAlN
					index 0641-552-	index 0641-556-	index 0641-552-	index 0641-556-	index 0641-552-	index 0641-552-
3	6	5	36	49	-100-210	-100-210	-100-710	-100-710	-	-
3,5	6	6	36	50	-100-215	-100-215	-100-715	-100-715	-	-
4	6	7	36	51	-100-220	-100-220	-100-720	-100-720	-	-
4,5	6	7	36	51	-100-225	-100-225	-100-725	-100-725	-	-
5	6	8	36	52	-100-230	-100-230	-100-730	-100-730	-	-
5,5	6	8	36	52	-100-232	-100-232	-100-732	-100-732	-	-
6	6	8	36	52	-100-235	-100-235	-100-735	-100-735	-101-035	-350-035
6,5	10	10	40	60	-100-237	-100-237	-100-736	-100-736	-	-
7	10	10	40	60	-100-240	-100-240	-100-740	-100-740	-101-040	-350-040
7,5	10	10	40	60	-100-242	-100-242	-100-742	-100-742	-	-
8	10	11	40	61	-100-245	-100-245	-100-745	-100-745	-101-045	-350-045
8,5	10	11	40	61	-100-247	-100-247	-100-747	-100-747	-	-
9	10	11	40	61	-100-250	-100-250	-100-750	-100-750	-101-050	-350-050
9,5	10	11	40	61	-100-252	-100-252	-100-752	-100-752	-	-
10	10	13	40	63	-100-255	-100-255	-100-755	-100-755	-101-055	-350-055
10,5	10	13	40	63	-100-257	-100-257	-100-757	-100-757	-	-
11	12	13	45	70	-100-260	-100-260	-100-760	-100-760	-101-060	-350-060
12	12	16	45	73	-100-265	-100-265	-100-765	-100-765	-101-065	-350-065
12,5	12	16	45	73	-100-267	-100-267	-100-767	-100-767	-	-
13	12	16	45	73	-100-270	-100-270	-100-770	-100-770	-	-
14	12	16	45	73	-100-275	-100-275	-100-775	-100-775	-101-075	-350-075
15	12	16	45	73	-100-280	-100-280	-100-780	-100-780	-	-
16	16	19	48	79	-100-285	-100-285	-100-785	-100-785	-101-085	-350-085
17	16	19	48	79	-100-290	-100-290	-100-790	-100-790	-	-
18	16	19	48	79	-100-295	-100-295	-100-795	-100-795	-	-
19	16	19	48	79	-100-300	-100-300	-100-800	-100-800	-	-
20	20	22	50	88	-100-305	-100-305	-100-805	-100-805	-	-
21	20	22	50	88	-100-310	-100-310	-100-810	-100-810	-	-
22	20	22	50	88	-100-315	-100-315	-100-815	-100-815	-	-
23	20	22	50	88	-100-320	-100-320	-100-820	-100-820	-	-
24	25	26	56	102	-100-325	-100-325	-100-825	-100-825	-	-
25	25	26	56	102	-100-330	-100-330	-100-830	-100-830	-	-
26	25	26	56	102	-100-335	-100-335	-100-835	-100-835	-	-
28	25	26	56	102	-100-345	-100-345	-100-845	-100-845	-	-
30	25	26	56	102	-100-355	-100-355	-100-855	-100-855	-	-
32	32	32	60	112	-100-360	-100-360	-100-860	-100-860	-	-
35	32	32	60	112	-100-370	-100-370	-100-870	-100-870	-	-
36	32	32	60	112	-100-372	-100-372	-100-872	-100-872	-	-

→ DIN 327-D K DIN 327-D K Golden Line - na specjalne zamówienie / on the special order / по спец. заказу

📌 Na specjalne zamówienie wykonujemy narzędzia o wymiarach innych niż zawarte w tabeli / For the special order we make tools of other dimensions than contained in table / По спец. заказу производим инструменты в размерах других, чем указанные в таблице



IV

N

DIN 327-(B,D) KR

Frezy trzpieniowe z czolem kulistym z chwytem walcowym

Ball nosed slot drills, helical flute with straight shank

Стержневые фрезы винтовые для шпоночных пазов с цилиндрическим хвостом

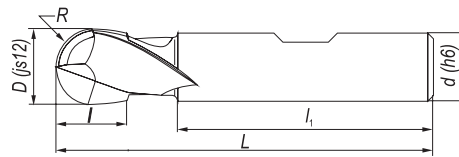
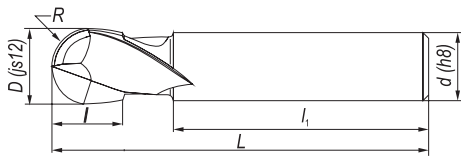

→ DIN 327-B K-R

D	R	d	l	l ₁	L	HSS	HSS Golden Line	HSS-E	HSS-E Golden Line
						index 0641-552-	index 0641-556-	index 0641-552-	index 0641-556-
4	2	6	7	36	51	-102-220	-102-220	-102-720	-102-720
5	2,5	6	8	36	52	-102-230	-102-230	-102-730	-102-730
6	3	6	8	36	52	-102-235	-102-235	-102-735	-102-735
7	3,5	10	10	40	60	-102-240	-102-240	-102-740	-102-740
8	4	10	11	40	61	-102-245	-102-245	-102-745	-102-745
9	4,5	10	13	40	61	-102-250	-102-250	-102-750	-102-750
10	5	10	13	40	63	-102-255	-102-255	-102-755	-102-755
11	5,5	12	16	45	70	-102-260	-102-260	-102-760	-102-760
12	6	12	16	45	73	-102-265	-102-265	-102-765	-102-765
13	6,5	12	16	45	73	-102-270	-102-270	-102-770	-102-770
14	7	12	16	45	73	-102-275	-102-275	-102-775	-102-775
15	7,5	12	16	45	73	-102-280	-102-280	-102-780	-102-780
16	8	16	19	48	79	-102-285	-102-285	-102-785	-102-785
17	8,5	16	19	48	79	-102-290	-102-290	-102-790	-102-790
18	9	16	19	48	79	-102-295	-102-295	-102-795	-102-795
19	9,5	16	19	48	79	-102-300	-102-300	-102-800	-102-800
20	10	20	22	50	88	-102-305	-102-305	-102-805	-102-805
22	11	20	22	50	88	-102-315	-102-315	-102-815	-102-815
23	11,5	20	22	50	88	-102-320	-102-320	-102-820	-102-820
24	12	25	26	56	102	-102-325	-102-325	-102-825	-102-825
25	12,5	25	26	56	102	-102-330	-102-330	-102-830	-102-830
26	13	25	26	56	102	-102-335	-102-335	-102-835	-102-835
28	14	25	26	56	102	-102-345	-102-345	-102-845	-102-845
30	15	25	26	56	102	-102-355	-102-355	-102-855	-102-855
32	16	32	32	60	112	-102-360	-102-360	-102-860	-102-860

→ DIN 327-D K-R DIN 327-D K-R Golden Line - na specjalne zamówienie / on the special order / по спец. заказу

i Na specjalne zamówienie wykonujemy narzędzia o wymiarach innych niż zawarte w tabeli / For the special order we make tools of other dimensions than contained in table / По спец. заказу производим инструменты в размерах других, чем указанные в таблице

1.1

1.2

3.1

3.2

5.1

5.2

6

IV

N

DIN 844-(A,B) K-N

Frezy trzpieniowe walcowo-czołowe, krótkie uniwersalne z chwytem walcowym

End mills, short universal with straight shank

Стержневые фрезы цилиндрическо-торцевые универсальные с цилиндрическим хвостом

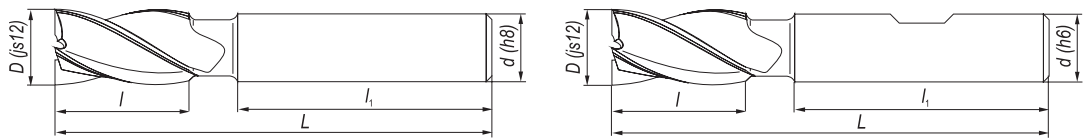

→ DIN 844-A K-N

D	d	l	l _i	L	Z	HSS	HSS Golden Line	HSS-E	HSS-E Golden Line	PM HSS-E	PM HSS-E TiAlN
						index 0641-512-	index 0641-516-	index 0641-512-	index 0641-516-	index 0641-512-	index 0641-512-
3	6	8	36	52	4	-100-030	-100-030	-100-530	-100-530	-	-
3,5	6	10	36	54	4	-100-035	-100-035	-100-535	-100-535	-	-
4	6	11	36	55	4	-100-040	-100-040	-100-540	-100-540	-	-
4,5	6	11	36	55	4	-100-045	-100-045	-100-545	-100-545	-	-
5	6	13	36	57	4	-100-050	-100-050	-100-550	-100-550	-	-
5,5	6	13	36	57	4	-100-055	-100-055	-100-555	-100-555	-	-
6	6	13	36	57	4	-100-060	-100-060	-100-560	-100-560	-100-810	-350-810
6,5	10	16	40	66	4	-100-065	-100-065	-100-565	-100-565	-	-
7	10	16	40	66	4	-100-070	-100-070	-100-570	-100-570	-100-815	-350-815
7,5	10	16	40	66	4	-100-075	-100-075	-100-575	-100-575	-	-
8	10	19	40	69	4	-100-080	-100-080	-100-580	-100-580	-100-820	-350-820
8,5	10	19	40	69	4	-100-085	-100-085	-100-585	-100-585	-	-
9	10	19	40	69	4	-100-090	-100-090	-100-590	-100-590	-100-825	-350-825
9,5	10	19	40	69	4	-100-095	-100-095	-100-595	-100-595	-	-
10	10	22	40	72	4	-100-100	-100-100	-100-600	-100-600	-100-830	-350-830
10,5	12	22	45	79	4	-100-105	-100-105	-100-605	-100-605	-	-
11	12	22	45	79	4	-100-110	-100-110	-100-610	-100-610	-100-835	-350-835
11,5	12	22	45	79	4	-100-115	-100-115	-100-615	-100-615	-	-
12	12	26	45	83	4	-100-120	-100-120	-100-620	-100-620	-100-840	-350-840
12,5	12	26	45	83	4	-100-125	-100-125	-100-625	-100-625	-	-
13	12	26	45	83	4	-100-130	-100-130	-100-630	-100-630	-	-
14	12	26	45	83	4	-100-135	-100-135	-100-635	-100-635	-100-850	-350-850
15	12	26	45	83	4	-100-140	-100-140	-100-640	-100-640	-	-
16	16	32	48	92	4	-100-145	-100-145	-100-645	-100-645	-100-860	-350-860
17	16	32	48	92	4	-100-150	-100-150	-100-650	-100-650	-	-
18	16	32	48	92	4	-100-155	-100-155	-100-655	-100-655	-	-
19	16	32	48	92	4	-100-160	-100-160	-100-660	-100-660	-	-
20	20	38	50	104	4	-100-165	-100-165	-100-665	-100-665	-	-
21	20	38	50	104	6	-100-170	-100-170	-100-670	-100-670	-	-
22	20	38	50	104	6	-100-175	-100-175	-100-675	-100-675	-	-
23	20	38	50	104	6	-100-180	-100-180	-100-680	-100-680	-	-
24	25	45	56	121	6	-100-185	-100-185	-100-685	-100-685	-	-
25	25	45	56	121	6	-100-190	-100-190	-100-690	-100-690	-	-
26	25	45	56	121	6	-100-195	-100-195	-100-695	-100-695	-	-
27	25	45	56	121	6	-100-200	-100-200	-100-700	-100-700	-	-
28	25	45	56	121	6	-100-205	-100-205	-100-705	-100-705	-	-
30	25	45	56	121	6	-100-215	-100-215	-100-715	-100-715	-	-
32	32	53	60	133	6	-100-225	-100-225	-100-725	-100-725	-	-
34	32	53	60	133	6	-100-230	-100-230	-100-730	-100-730	-	-
35	32	53	60	133	6	-100-235	-100-235	-100-735	-100-735	-	-
36	32	53	60	133	6	-100-240	-100-240	-100-740	-100-740	-	-

→ DIN 844-B K-N DIN 844-B K-N Golden Line - na specjalne zamówienie / on the special order / по спец. заказу

ⓘ Na specjalne zamówienie wykonujemy narzędzia o wymiarach innych niż zawarte w tabeli / For the special order we make tools of other dimensions than contained in table / По спец. заказу производим инструменты в размерах других, чем указанные в таблице

HSS / HSS-E

1.1

1.2

3.1

3.2

PM HSS-E

1.1

1.2

1.3

2.1

2.2

3.1

3.2

IV

N

DIN 844-(A,B) K-M-N

Frezy trzpieniowe walcowo-czołowe, krótkie o ostrzach centralnych z chwytem walcowym

End mills, short center-cutting with straight shank

Стержневые фрезы цилиндрическо-торцевые короткие с центральными лезвиями с цилиндрическим хвостом

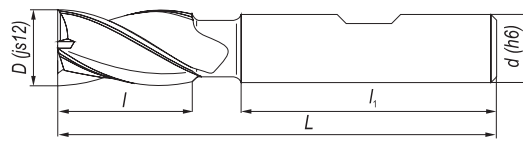
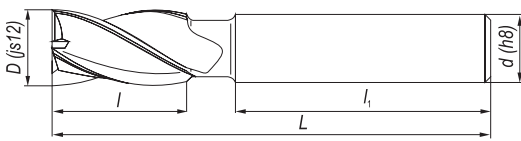

→ DIN 844-A K-M-N

D	d	l	l ₁	L	Z	HSS	HSS Golden Line	HSS-E	HSS-E Golden Line	PM HSS-E	PM HSS-E TiAlN
						index 0641-512-	index 0641-516-	index 0641-512-	index 0641-516-	index 0641-512-	index 0641-512-
3	6	8	36	52	4	101-030	-101-030	-101-530	-101-530	-	-
4	6	11	36	55	4	-101-040	-101-040	-101-540	-101-540	-	-
5	6	13	36	57	4	-101-050	-101-050	-101-550	-101-550	-	-
6	6	13	36	57	4	-101-060	-101-060	-101-560	-101-560	-101-910	-351-910
7	10	16	40	66	4	-101-070	-101-070	-101-570	-101-570	-101-915	-351-915
8	10	19	40	69	4	-101-080	-101-080	-101-580	-101-580	-101-920	-351-920
9	10	19	40	69	4	-101-090	-101-090	-101-590	-101-590	-101-925	-351-925
10	10	22	40	72	4	-101-100	-101-100	-101-600	-101-600	-101-930	-351-930
11	12	22	45	79	4	-101-110	-101-110	-101-610	-101-610	-101-935	-351-935
12	12	26	45	83	4	-101-120	-101-120	-101-620	-101-620	-101-940	-351-940
13	12	26	45	83	4	-101-130	-101-130	-101-630	-101-630	-	-
14	12	26	45	83	4	-101-135	-101-135	-101-635	-101-635	-101-950	-351-950
15	12	26	45	83	4	-101-140	-101-140	-101-640	-101-640	-	-
16	16	32	48	92	4	-101-145	-101-145	-101-645	-101-645	-101-960	-351-960
17	16	32	48	92	4	-101-150	-101-150	-101-650	-101-650	-	-
18	16	32	48	92	4	-101-155	-101-155	-101-655	-101-655	-	-
19	16	32	48	92	4	-101-160	-101-160	-101-660	-101-660	-	-
20	20	38	50	104	4	-101-165	-101-165	-101-665	-101-665	-	-
21	20	38	50	104	6	-101-170	-101-170	-101-670	-101-670	-	-
22	20	38	50	104	6	-101-175	-101-175	-101-675	-101-675	-	-
23	20	38	50	104	6	-101-180	-101-180	-101-680	-101-680	-	-
24	25	45	56	121	6	-101-185	-101-185	-101-685	-101-685	-	-
25	25	45	56	121	6	-101-190	-101-190	-101-690	-101-690	-	-
26	25	45	56	121	6	-101-195	-101-195	-101-695	-101-695	-	-
28	25	45	56	121	6	-101-205	-101-205	-101-705	-101-705	-	-
30	25	45	56	121	6	-101-215	-101-215	-101-715	-101-715	-	-
32	32	53	60	133	6	-101-225	-101-225	-101-725	-101-725	-	-

→ DIN 844-B K-M-N DIN 844-B K-M-N Golden Line - na specjalne zamówienie / on the special order / no спец. заказу

i Na specjalne zamówienie wykonujemy narzędzia o wymiarach innych niż zawarte w tabeli / For the special order we make tools of other dimensions than contained in table / По спец. заказу производим инструменты в размерах других, чем указанные в таблице



DIN 844-(A,B) L-N



Frezy trzpieniowe walcowo-czołowe, długie uniwersalne z chwytem walcowym

End mills, long universal with straight shank

Стержневые фрезы цилиндрическо-торцевые длинные универсальные с цилиндрическим хвостом

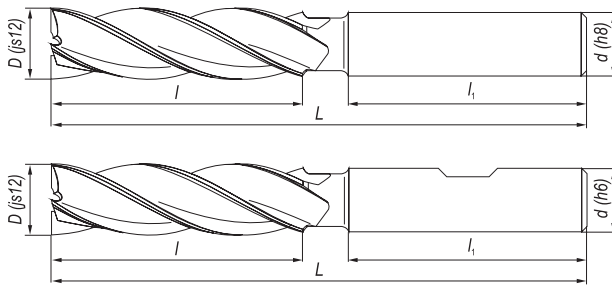

→ DIN 844-A L-N

D	d	l	li	L	Z	HSS	HSS Golden Line	HSS-E	HSS-E Golden Line	PM HSS-E	PM HSS-E TiAlN
						index 0641-512-	index 0641-516-	index 0641-512-	index 0641-516-	index 0641-512-	index 0641-512-
3	6	12	36	56	4	-110-030	-110-030	-110-530	-110-530	-	-
3,5	6	15	36	59	4	-110-035	-110-035	-110-535	-110-535	-	-
4	6	19	36	63	4	-110-040	-110-040	-110-540	-110-540	-	-
4,5	6	19	36	63	4	-110-045	-110-045	-110-545	-110-545	-	-
5	6	24	36	68	4	-110-050	-110-050	-110-550	-110-550	-	-
5,5	6	24	36	68	4	-110-055	-110-055	-110-555	-110-555	-	-
6	6	24	36	68	4	-110-060	-110-060	-110-560	-110-560	-110-810	-360-810
6,5	10	30	40	80	4	-110-065	-110-065	-110-565	-110-565	-	-
7	10	30	40	80	4	-110-070	-110-070	-110-570	-110-570	-110-815	-360-815
7,5	10	30	40	80	4	-110-075	-110-075	-110-575	-110-575	-	-
8	10	38	40	88	4	-110-080	-110-080	-110-580	-110-580	-110-820	-360-820
8,5	10	38	40	88	4	-110-085	-110-085	-110-585	-110-585	-	-
9	10	38	40	88	4	-110-090	-110-090	-110-590	-110-590	-110-825	-360-825
9,5	10	38	40	88	4	-110-095	-110-095	-110-595	-110-595	-	-
10	10	45	40	95	4	-110-100	-110-100	-110-600	-110-600	-110-830	-360-830
11	12	45	45	102	4	-110-110	-110-110	-110-610	-110-610	-110-835	-360-835
12	12	53	45	110	4	-110-120	-110-120	-110-620	-110-620	-110-840	-360-840
13	12	53	45	110	4	-110-130	-110-130	-110-630	-110-630	-	-
14	12	53	45	110	4	-110-135	-110-135	-110-635	-110-635	-110-850	-360-850
15	12	53	45	110	4	-110-140	-110-140	-110-640	-110-640	-	-
16	16	63	48	123	4	-110-145	-110-145	-110-645	-110-645	-110-860	-360-860
17	16	63	48	123	4	-110-150	-110-150	-110-650	-110-650	-	-
18	16	63	48	123	4	-110-155	-110-155	-110-655	-110-655	-	-
19	16	63	48	123	4	-110-160	-110-160	-110-660	-110-660	-	-
20	20	75	50	141	4	-110-165	-110-165	-110-665	-110-665	-	-
21	20	75	50	141	6	-110-170	-110-170	-110-670	-110-670	-	-
22	20	75	50	141	6	-110-175	-110-175	-110-675	-110-675	-	-
23	20	75	50	141	6	-110-180	-110-180	-110-680	-110-680	-	-
24	25	90	56	166	6	-110-185	-110-185	-110-685	-110-685	-	-
25	25	90	56	166	6	-110-190	-110-190	-110-690	-110-690	-	-
26	25	90	56	166	6	-110-195	-110-195	-110-695	-110-695	-	-
28	25	90	56	166	6	-110-205	-110-205	-110-705	-110-705	-	-
30	25	90	56	166	6	-110-215	-110-215	-110-715	-110-715	-	-
32	32	106	60	186	6	-110-225	-110-225	-110-725	-110-725	-	-
34	32	106	60	186	6	-110-230	-110-230	-110-730	-110-730	-	-
35	32	106	60	186	6	-110-235	-110-235	-110-735	-110-735	-	-
36	32	106	60	186	6	-110-240	-110-240	-110-740	-110-740	-	-

→ DIN 844-B L-N DIN 844-B L-N Golden Line - na specjalne zamówienie / on the special order / no спец. заказ

ⓘ Na specjalne zamówienie wykonujemy narzędzia o wymiarach innych niż zawarte w tabeli / For the special order we make tools of other dimensions than contained in table / По спец. заказу производим инструменты в размерах других, чем указанные в таблице

HSS / HSS-E 1.1

PM HSS-E 1.2

3.1 1.3

3.2 2.1

2.2

3.1

3.2

IV

N

DIN 844-(A,B) L-M-N

Frezy trzpieniowe walcowo-czołowe, długie o ostrzach centralnych z chwytem walcowym

End mills, long center-cutting with straight shank

Стержневые фрезы цилиндрическо-торцевые длинные с центральными лезвиями с цилиндрическим хвостом

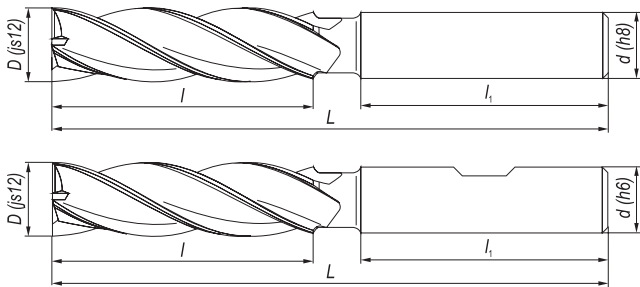

→ DIN 844-A L-M-N

D	d	l	l ₁	L	Z	HSS	HSS Golden Line	HSS-E	HSS-E Golden Line	PM HSS-E	PM HSS-E TiAlN
						index 0641-512-	index 0641-516-	index 0641-512-	index 0641-516-	index 0641-512-	index 0641-512-
3	6	12	36	56	4	-111-035	-111-035	-111-535	-111-535	-	-
4	6	19	36	63	4	-111-040	-111-040	-111-540	-111-540	-	-
5	6	24	36	68	4	-111-050	-111-050	-111-550	-111-550	-	-
6	6	24	36	68	4	-111-060	-111-060	-111-560	-111-560	-111-910	-362-010
7	10	30	40	80	4	-111-070	-111-070	-111-570	-111-570	-111-915	-362-015
8	10	38	40	88	4	-111-080	-111-080	-111-580	-111-580	-111-920	-362-020
9	10	38	40	88	4	-111-090	-111-090	-111-590	-111-590	-111-925	-362-025
10	10	45	40	95	4	-111-100	-111-100	-111-600	-111-600	-111-930	-362-030
11	12	45	45	102	4	-111-110	-111-110	-111-610	-111-610	-111-935	-362-035
12	12	53	45	110	4	-111-120	-111-120	-111-620	-111-620	-111-940	-362-040
13	12	53	45	110	4	-111-130	-111-130	-111-630	-111-630	-	-
14	12	53	45	110	4	-111-135	-111-135	-111-635	-111-635	-111-950	-362-050
15	12	53	45	110	4	-111-140	-111-140	-111-640	-111-640	-	-
16	16	63	48	123	4	-111-145	-111-145	-111-645	-111-645	-111-960	-362-060
17	16	63	48	123	4	-111-150	-111-150	-111-650	-111-650	-	-
18	16	63	48	123	4	-111-155	-111-155	-111-655	-111-655	-	-
19	16	63	48	123	4	-111-160	-111-160	-111-660	-111-660	-	-
20	20	75	50	141	4	-111-165	-111-165	-111-665	-111-665	-	-
21	20	75	50	141	6	-111-170	-111-170	-111-670	-111-670	-	-
22	20	75	50	141	6	-111-175	-111-175	-111-675	-111-675	-	-
23	20	75	50	141	6	-111-180	-111-180	-111-680	-111-680	-	-
24	25	90	56	166	6	-111-185	-111-185	-111-685	-111-685	-	-
25	25	90	56	166	6	-111-190	-111-190	-111-690	-111-690	-	-
26	25	90	56	166	6	-111-200	-111-200	-111-700	-111-700	-	-
28	25	90	56	166	6	-111-210	-111-210	-111-710	-111-710	-	-
30	25	90	56	166	6	-111-220	-111-220	-111-720	-111-720	-	-
32	32	106	60	186	6	-111-225	-111-225	-111-725	-111-725	-	-

→ DIN 844-B L-M-N DIN 844-B L-M-N Golden Line - na specjalne zamówienie / on the special order / по спец. заказу

i Na specjalne zamówienie wykonujemy narzędzia o wymiarach innych niż zawarte w tabeli / For the special order we make tools of other dimensions than contained in table / По спец. заказу производим инструменты в размерах других, чем указанные в таблице



DIN 845-B K-N

Frezy trzpieniowe walcowo-czołowe, krótkie uniwersalne z chwytem stożkowym Morse'a

End mills, short universal with Morse taper shank

Стержневые фрезы цилиндрическо-торцевые короткие универсальные с коническим хвостовиком Морзе

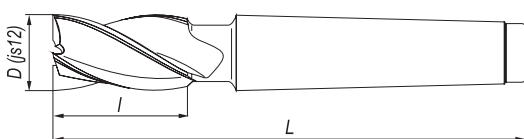

→ DIN 845-B K-N

D	I	L	Nr stoż / MT / HP конуса	Z	HSS index 0641-512-	HSS Golden Line index 0641-516-	HSS-E index 0641-512-	HSS-E Golden Line index 0641-516-
10	22	92	1	4	-400-020	-400-020	-400-520	-400-520
11	22	92	1	4	-400-025	-400-025	-400-525	-400-525
12	26	96	1	4	-400-030	-400-030	-400-530	-400-530
13	26	96	1	4	-400-035	-400-035	-400-535	-400-535
14	26	111	2	4	-400-040	-400-040	-400-540	-400-540
15	26	111	2	4	-400-045	-400-045	-400-545	-400-545
16	32	117	2	4	-400-050	-400-050	-400-550	-400-550
17	32	117	2	4	-400-055	-400-055	-400-555	-400-555
18	32	117	2	4	-400-060	-400-060	-400-560	-400-560
19	32	117	2	4	-400-065	-400-065	-400-565	-400-565
20	38	123	2	4	-400-070	-400-070	-400-570	-400-570
21	38	123	2	6	-400-075	-400-075	-400-575	-400-575
22	38	123	2	6	-400-080	-400-080	-400-580	-400-580
23	38	123	2	6	-400-085	-400-085	-400-585	-400-585
24	45	147	3	6	-400-090	-400-090	-400-590	-400-590
25	45	147	3	6	-400-095	-400-095	-400-595	-400-595
26	45	147	3	6	-400-100	-400-100	-400-600	-400-600
27	45	147	3	6	-400-105	-400-105	-400-605	-400-605
28	45	147	3	6	-400-110	-400-110	-400-610	-400-610
29	45	147	3	6	-400-115	-400-115	-400-615	-400-615
30	45	147	3	6	-400-120	-400-120	-400-620	-400-620
32	53	178	4	6	-400-130	-400-130	-400-630	-400-630
34	53	178	4	6	-400-135	-400-135	-400-635	-400-635
35	53	178	4	6	-400-140	-400-140	-400-640	-400-640
36	53	178	4	6	-400-145	-400-145	-400-645	-400-645
38	63	188	4	6	-400-150	-400-150	-400-650	-400-650
40	63	188	4	6	-400-155	-400-155	-400-655	-400-655
45	63	188	4	8	-400-160	-400-160	-400-660	-400-660
50	75	233	5	8	-400-165	-400-165	-400-665	-400-665
56	75	233	5	8	-400-170	-400-170	-400-670	-400-670
63	90	248	5	8	-400-175	-400-175	-400-675	-400-675

i Na specjalne zamówienie wykonujemy narzędzia o wymiarach innych niż zawarte w tabeli / For the special order we make tools of other dimensions than contained in table / По спец. заказу производим инструменты в размерах других, чем указанные в таблице

1.1

1.2

3.1

3.2

IV

N

DIN 845-B L-N

Frezy trzpieniowe walcowo-czołowe, długie uniwersalne z chwytem stożkowym Morse'a

End mills, long universal with Morse taper shank

Стержневые фрезы цилиндрическо-торцевые длинные универсальные с коническим хвостовиком Морзе

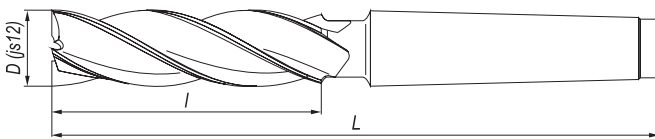

→ DIN 845-B L-N

D	l	L	Nr stoż MT/H ^o konusu	Z	HSS index 0641-512-	HSS Golden Line index 0641-516-	HSS-E index 0641-512-	HSS-E Golden Line index 0641-516-
10	45	115	1	4	-410-020	-410-020	-410-320	-410-320
11	45	115	1	4	-410-025	-410-025	-410-325	-410-325
12	53	123	1	4	-410-030	-410-030	-410-330	-410-330
13	53	123	1	4	-410-035	-410-035	-410-335	-410-335
14	53	138	2	4	-410-040	-410-040	-410-340	-410-340
15	53	138	2	4	-410-045	-410-045	-410-345	-410-345
16	63	148	2	4	-410-050	-410-050	-410-350	-410-350
17	63	148	2	4	-410-055	-410-055	-410-355	-410-355
18	63	148	2	4	-410-060	-410-060	-410-360	-410-360
19	63	148	2	4	-410-065	-410-065	-410-365	-410-365
20	75	160	2	4	-410-070	-410-070	-410-370	-410-370
21	75	160	2	6	-410-075	-410-075	-410-375	-410-375
22	75	160	2	6	-410-080	-410-080	-410-380	-410-380
23	75	160	2	6	-410-085	-410-085	-410-385	-410-385
24	90	192	3	6	-410-090	-410-090	-410-390	-410-390
25	90	192	3	6	-410-095	-410-095	-410-395	-410-395
26	90	192	3	6	-410-100	-410-100	-410-400	-410-400
27	90	192	3	6	-410-105	-410-105	-410-405	-410-405
28	90	192	3	6	-410-110	-410-110	-410-410	-410-410
29	90	192	3	6	-410-115	-410-115	-410-415	-410-415
30	90	192	3	6	-410-120	-410-120	-410-420	-410-420
32	106	231	4	6	-410-130	-410-130	-410-430	-410-430
34	106	231	4	6	-410-135	-410-135	-410-435	-410-435
35	106	231	4	6	-410-140	-410-140	-410-440	-410-440
36	106	231	4	6	-410-145	-410-145	-410-445	-410-445
38	125	250	4	6	-410-150	-410-150	-410-450	-410-450
40	125	250	4	6	-410-155	-410-155	-410-455	-410-455
45	125	250	4	8	-410-160	-410-160	-410-460	-410-460
50	150	308	5	8	-410-165	-410-165	-410-465	-410-465
56	150	308	5	8	-410-170	-410-170	-410-470	-410-470
63	180	338	5	8	-410-175	-410-175	-410-475	-410-475

1.1

1.2

3.1

3.2

IV

N

Na specjalne zamówienie wykonujemy narzędzia o wymiarach innych niż zawarte w tabeli / For the special order we make tools of other dimensions than contained in table / По спец. заказу производим инструменты в размерах других, чем указанные в таблице

DIN 1880-N, W, NR

Frezy walcowo-czołowe, nasadzone z zabierakiem czołowym

Shell end mills with keyslot

Фрезы цилиндрическо-торцевые, насадные с торцевым поводком



DIN 1880-N

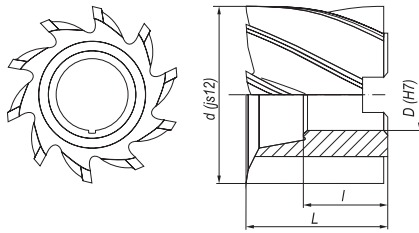

DIN 1880-W

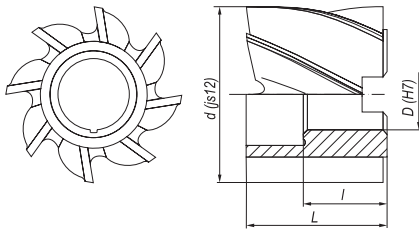

DIN 1880-NR

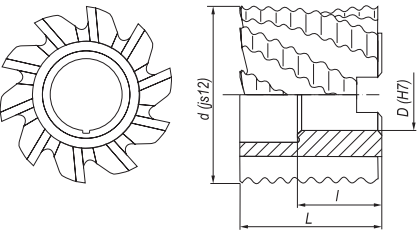

N W

1.1 5.1

1.2 5.2

3.1 6

3.2

IV

N

NR

W

→ DIN 1880-N

→ DIN 1880-NR

→ DIN 1880-W

d	D	I	L	Z	DIN 1880-N		DIN 1880-NR		DIN 1880-W	
					HSS	HSS-E	HSS-E	Z	HSS	HSS-E
					index 0641-511-	index 0641-511-	index 0641-511-		index 0641-511-	index 0641-511-
40	16	19	32	8	-700-010	-700-510	-701-510	6	-710-010	-710-510
50	22	21	36	8	-700-020	-700-520	-701-520	6	-710-020	-710-520
63	27	23	40	8	-700-030	-700-530	-701-530	6	-710-030	-710-530
80	27	23	45	10	-700-040	-700-540	-701-540	6	-710-040	-710-540
100	32	26	50	12	-700-050	-700-550	-701-550	6	-710-050	-710-550
125	40	29	56	14	-700-060	-700-560	-701-560	8	-710-060	-710-560

i Na specjalne zamówienie wykonujemy narzędzia o wymiarach innych niż zawarte w tabeli / For the special order we make tools of other dimensions than contained in table / По спец. заказу производим инструменты в размерах других, чем указанные в таблице

Frezy modułowe krążkowe do kół zębatych o zarysie ewolwentowym (m = 0,5÷7 kpl. 8-sztukowe)

Involute gear cutters (m = 0,5÷7 8 pcs in set)

Модульные дисковые фрезы для шестерни револьверного профиля (m = 0,5÷7 кмп. 8-штуковые)

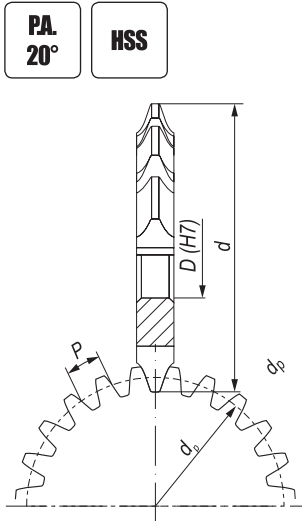

PA.
20°

HSS

$d_p = zm$
 $m = P\pi$

gdzie / where / где:

- dp** - średnica podziałowa / pitch diameter / средний диаметр
- P** - podziałka nominalna (mierzona po łuku) / nominal pitch (measure along arc) / номинальная шкала (измеряемая по дуге)
- z** - liczba zębów koła obrabianego / range of teeth cut / количество зубьев обрабатываемого колеса
- m** - moduł nominalny / nominal module / номинальный модуль
- P.A.** - kąt przyporu 20° / pressure angle 20° / угол зацепления 20°



→ NFMa Nr freza w kpl. / Liczba zębów koła obrabianego / Number of cutter in set / Range of teeth cut / Но фрезы в комплекте / Количество зубьев обрабатываемого колеса

Modul Module / Модуль m	d	D	index 0641-561-000...								kpl. set / кпл. 12÷∞
			#1 12÷13	#2 14÷16	#3 17÷20	#4 21÷25	#5 26÷34	#6 35÷54	#7 55÷134	#8 135÷∞	
0,5	40	16	-201	-202	-203	-204	-205	-206	-207	-208	-209
0,7	40	16	-231	-232	-233	-234	-235	-236	-237	-238	-239
0,75	40	16	-241	-242	-243	-244	-245	-246	-247	-248	-249
0,8	40	16	-251	-252	-253	-254	-255	-256	-257	-258	-259
1	50	16	-271	-272	-273	-274	-275	-276	-277	-278	-279
1,25	50	16	-291	-292	-293	-294	-295	-296	-297	-298	-299
1,5	56	22	-311	-312	-313	-314	-315	-316	-317	-318	-319
1,75	56	22	-321	-322	-323	-324	-325	-326	-327	-328	-329
2	63	22	-331	-332	-333	-334	-335	-336	-337	-338	-339
2,25	63	22	-341	-342	-343	-344	-345	-346	-347	-348	-349
2,5	63	22	-351	-352	-353	-354	-355	-356	-357	-358	-359
2,75	71	27	-361	-362	-363	-364	-365	-366	-367	-368	-369
3	71	27	-371	-372	-373	-374	-375	-376	-377	-378	-379
3,25	71	27	-381	-382	-383	-384	-385	-386	-387	-388	-389
3,5	80	27	-391	-392	-393	-394	-395	-396	-397	-398	-399
3,75	80	27	-401	-402	-403	-404	-405	-406	-407	-408	-409
4	80	27	-411	-412	-413	-414	-415	-416	-417	-418	-419
4,5	90	32	-431	-432	-433	-434	-435	-436	-437	-438	-439
5	90	32	-451	-452	-453	-454	-455	-456	-457	-458	-459
6	100	32	-471	-472	-473	-474	-475	-476	-477	-478	-479
7	100	32	-491	-492	-493	-494	-495	-496	-497	-498	-499

1.1

1.2

1.3

2.1

2.2

3.1

3.2

5.1

5.2

IV

N

Na specjalne zamówienie wykonujemy narzędzia o wymiarach innych niż zawarte w tabeli / For the special order we make tools of other dimensions than contained in table / По спец. заказу производим инструменты в размерах других, чем указанные в таблице

NFMb

Frezy modułowe krążkowe do kół zębatych o zarysie ewolwentowym (m = 8)

Involute gear cutters (m = 8 pcs)

Модульные дисковые фрезы для шестерни револьверного профиля (m = 8)

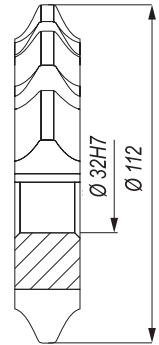

→ **NFMb** Nr freza w kpl. / Liczba zębów koła obrabianego / Number of cutter in set / Range of teeth cut /
Но фрезы в комплекте / Количество зубьев обрабатываемого колеса

Moduł Module / Модуль m	index 0641-561-001-...								kpl. / set / кпл.
	#1	#2	#3	#4	#5	#6	#7	#8	
8	12÷13	14÷16	17÷20	21÷25	26÷34	35÷54	55÷134	135÷∞	12÷∞
	-001	-003	-005	-007	-009	-011	-013	-015	-017

NFMt

Frezy krążkowe do kół łańcuchowych

Roller chain sprocket milling cutters

Дисковые фрезы для цепных колёс

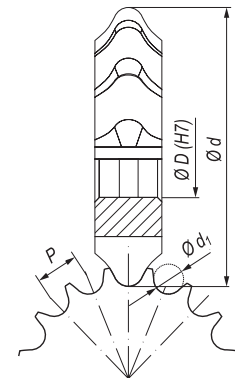

→ **NFMt** Nr freza w kpl. / Number of cutter in set / № фрезы в комплекте

Podziałka Pitch / Шкала P		Rolka Roller / Ролик d ₁	d	D [h7]	index 0641-561-010-...			
cale / inch / дюймы	mm	mm	mm	mm	#1	#2	#3	kpl. / set / кпл.
5/16	7,94	4,76	63	22	-100	-110	-120	-130
3/8	9,525	6,35	70	27	-200	-210	-220	-230
1/2	12,7	8,51	75	27	-300	-310	-320	-330
5/8	15,875	10,16	85	32	-400	-410	-420	-430
3/4	19,05	12,07	90	32	-500	-510	-520	-530
1	25,4	15,88	100	32	-600	-610	-620	-630

Nr freza Number of milling cutter / № фрезы	Liczba zębów koła obrabianego Range of teeth cut / Количество зубьев обрабатываемого колеса
# 1	9÷13
# 2	14÷22
# 3	23÷150

1.1

1.2

1.3

2.1

2.2

3.1

3.2

5.1

5.2

IV

N



NFPI

Frezy trzpieniowe do rowków na wpusty, długie z chwytem walcowym

Slot drills, helical flute, long with straight shank

Стержневые фрезы винтовые для шпоночных пазов, длинные с цилиндрическим хвостом

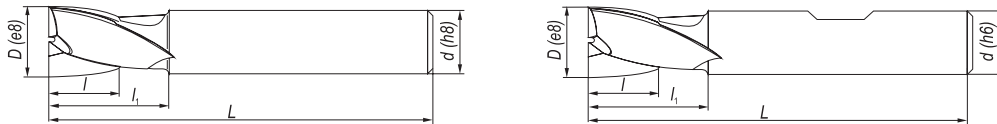

→ NFPI-A

D	d	l	li	L	HSS index 0641-551-	HSS-E index 0641-551-	PM HSS-E index 0641-551-
4	6	11	14	63	-105-040	-105-440	-105-840
5	6	13	16	68	-105-050	-105-450	-105-850
6	6	13	-	68	-105-060	-105-460	-105-860
7	10	16	19	80	-105-070	-105-470	-105-870
8	10	19	22	88	-105-080	-105-480	-105-880
9	10	19	22	88	-105-090	-105-490	-105-890
10	10	22	-	95	-105-100	-105-500	-105-900
12	12	26	-	110	-105-120	-105-520	-105-920
14	12	26	-	110	-105-140	-105-540	-105-940
16	16	32	-	123	-105-160	-105-560	-105-960
18	16	32	-	123	-105-180	-105-580	-
20	20	38	-	141	-105-200	-105-600	-

→ NFPI-B - na specjalne zamówienie / on the special order / по спец. заказу

NFPz

Frezy trzpieniowe z chwytem walcowym do usuwania zgrzewów punktowych

End mills with straight shank for spot welds removing

Стержневые фрезы с цилиндрическим хвостом для удаления пунтктовых швов

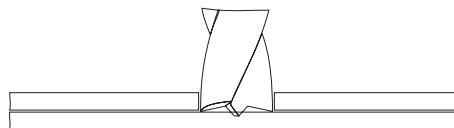
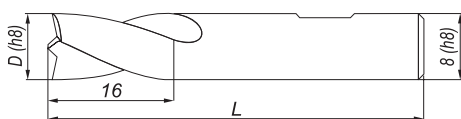

→ NFPz

D	L	HSS-E index 0641-519-	HSS-E Golden Line index 0641-520-
8	36	-109-520	-109-520
8	45	-109-620	-109-620



1.1

1.2

1.3

2.1

2.2

3.1

3.2

5.1

5.2

IV

N

DIN 844-(A,B) K-NR, DIN 844-(A,B) K-M-NR

Frezy trzpieniowe walcowo-czołowe, krótkie do obróbki zgrubnej z chwytem walcowym

Roughing end mills, short with straight shank

Стержневые фрезы цилиндрическо-торцевые, короткие для черновой обработки с цилиндрическим хвостом

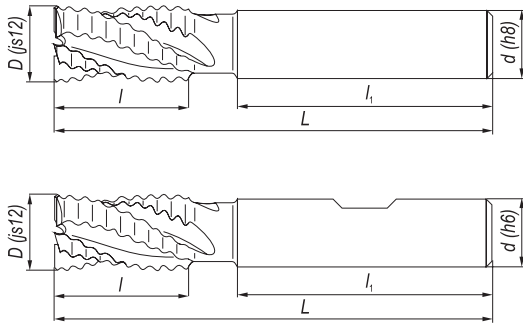

→ DIN 844-A K-M-NR



→ DIN 844-A K-NR

HSS-E PM
HSS-E

1.1 1.1

1.2 1.2

3.1 1.3

3.2 2.1

2.2

3.1

3.2

IV

NR

D	d	l	li	L	Z	HSS-E	HSS-E Golden Line	PM HSS-E	PM HSS-E TiAlN	HSS-E	HSS-E Golden Line	PM HSS-E	PM HSS-E TiAlN
						index 0641-512-	index 0641-516-	index 0641-512-	index 0641-512-	index 0641-512-	index 0641-516-	index 0641-512-	index 0641-512-
10	10	22	40	72	4	-103-600	-103-600	-104-210	-354-210	-103-800	-103-800	-104-010	-354-010
11	12	22	45	79	4	-103-610	-103-610	-104-215	-354-215	-103-810	-103-810	-104-015	-354-015
12	12	26	45	83	4	-103-620	-103-620	-104-220	-354-220	-103-820	-103-820	-104-020	-354-020
13	12	26	45	83	4	-103-630	-103-630	-	-	-103-830	-103-830	-	-
14	12	26	45	83	4	-103-635	-103-635	-104-230	-135-230	-103-835	-103-835	-104-030	-354-030
15	12	26	45	83	4	-103-640	-103-640	-	-	-103-840	-103-840	-	-
16	16	32	48	92	4	-103-645	-103-645	-104-240	-135-240	-103-845	-103-845	-104-040	-354-040
18	16	32	48	92	4	-103-655	-103-655	-	-	-103-855	-103-855	-	-
20	20	38	50	104	4	-103-665	-103-665	-	-	-103-865	-103-865	-	-
22	20	38	50	104	6	-103-675	-103-675	-	-	-103-875	-103-875	-	-
24	25	45	56	121	6	-103-685	-103-685	-	-	-103-885	-103-885	-	-
25	25	45	56	121	6	-103-690	-103-690	-	-	-103-890	-103-890	-	-
26	25	45	56	121	6	-103-695	-103-695	-	-	-103-895	-103-895	-	-
28	25	45	56	121	6	-103-705	-103-705	-	-	-103-905	-103-905	-	-
30	25	45	56	121	6	-103-715	-103-715	-	-	-103-915	-103-915	-	-
32	32	53	60	133	6	-103-720	-103-720	-	-	-103-920	-103-920	-	-

→ DIN 844-B K-M-NR, DIN 844-B K-NR DIN 844-B K-M-NR, DIN 844-B K-NR Golden Line - na specjalne zamówienie / on the special order / по спец. заказу

i Na specjalne zamówienie wykonujemy narzędzia o wymiarach innych niż zawarte w tabeli / For the special order we make tools of other dimensions than contained in table / По спец. заказу производим инструменты в размерах других, чем указанные в таблице

DIN 844-(A,B) L-NR, DIN 844-(A,B) L-M-NR

Frezy trzpieniowe walcowo-czołowe, długie do obróbki zgrubnej z chwytem walcowym

Roughing end mills, long with straight shank

Стержневые фрезы цилиндрическо-торцевые, длинные для черновой обработки с цилиндрическим хвостом

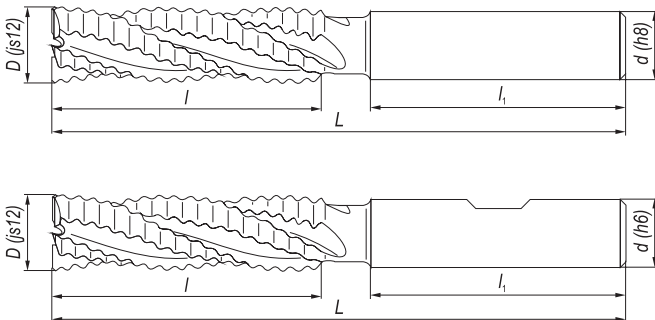

→ DIN 844-A L-M-NR



→ DIN 844-A L-NR

D	d	l	li	L	Z	HSS-E		PM HSS-E		HSS-E		PM HSS-E	
						index 0641-512-	index 0641-516-	index 0641-512-	index 0641-512-	index 0641-512-	index 0641-516-	index 0641-512-	index 0641-512-
10	10	45	40	95	4	-114-600	-114-600	-114-910	-364-910	-113-800	-113-800	-114-810	-364-810
11	12	45	45	102	4	-114-610	-114-610	-114-915	-364-915	-113-810	-113-810	-114-815	-364-815
12	12	53	45	110	4	-114-620	-114-620	-114-920	-364-920	-113-820	-113-820	-114-820	-364-820
13	12	53	45	110	4	-114-630	-114-630	-	-	-113-830	-113-830	-	-
14	12	53	45	110	4	-114-635	-114-635	-114-930	-364-930	-113-835	-113-835	-114-830	-364-830
15	12	53	45	110	4	-114-640	-114-640	-	-	-113-840	-113-840	-	-
16	16	63	48	123	4	-114-645	-114-645	-114-940	-364-940	-113-845	-113-845	-114-840	-364-840
18	16	63	48	123	4	-114-655	-114-655	-	-	-113-855	-113-855	-	-
20	20	75	50	141	4	-114-665	-114-665	-	-	-113-865	-113-865	-	-
22	20	75	50	141	6	-114-675	-114-675	-	-	-113-875	-113-875	-	-
24	25	90	56	166	6	-114-685	-114-685	-	-	-113-885	-113-885	-	-
25	25	90	56	166	6	-114-690	-114-690	-	-	-113-890	-113-890	-	-
26	25	90	56	166	6	-114-695	-114-695	-	-	-113-895	-113-895	-	-
28	25	90	56	166	6	-114-705	-114-705	-	-	-113-905	-113-905	-	-
30	25	90	56	166	6	-114-715	-114-715	-	-	-113-915	-113-915	-	-
32	32	106	60	186	6	-114-720	-114-720	-	-	-113-920	-113-920	-	-

→ DIN 844-B L-M-NR, DIN 844-B L-NR DIN 844-B L-M-NR, DIN 844-B L-NR Golden Line - na specjalne zamówienie / on the special order / по спец. заказу

Na specjalne zamówienie wykonujemy narzędzia o wymiarach innych niż zawarte w tabeli / For the special order we make tools of other dimensions than contained in table / По спец. заказу производим инструменты в размерах других, чем указанные в таблице

HSS-E PM HSS-E
1.1 **1.1**
1.2 **1.2**
3.1 **1.3**
3.2 **2.1**
2.2
3.1
3.2

IV

NR

DIN 845-B K-NR, DIN 845-B K-M-NR

Frezy trzpieniowe walcowo-czołowe, krótkie do obróbki zgrubnej z chwytem stożkowym Morse'a

Roughing end mills, short with Morse taper shank

Стержневые фрезы цилиндрическо-торцевые, короткие для черновой обработки с коническим хвостовиком Морзе

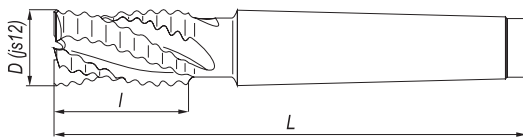

→ DIN 845-B K-M-NR



→ DIN 845-B K-NR

D	I	L	Nr stoż MT/HP конуса	Z	DIN 845-B K-M-NR		DIN 845-B K-NR	
					HSS-E index 0641-512-	HSS-E Golden Line index 0641-516-	HSS-E index 0641-512-	HSS-E Golden Line index 0641-516-
10	22	92	1	4	-404-720	-404-720	-403-720	-403-720
11	22	92	1	4	-404-725	-404-725	-403-725	-403-725
12	26	96	1	4	-404-730	-404-730	-403-730	-403-730
13	26	96	1	4	-404-735	-404-735	-403-735	-403-735
14	26	111	2	4	-404-740	-404-740	-403-740	-403-740
15	26	111	2	4	-404-745	-404-745	-403-745	-403-745
16	32	117	2	4	-404-750	-404-750	-403-750	-403-750
18	32	117	2	4	-404-760	-404-760	-403-760	-403-760
20	38	123	2	4	-404-770	-404-770	-403-770	-403-770
22	38	123	2	6	-404-780	-404-780	-403-780	-403-780
24	45	147	3	6	-404-790	-404-790	-403-790	-403-790
25	45	147	3	6	-404-795	-404-795	-403-795	-403-795
26	45	147	3	6	-404-800	-404-800	-403-800	-403-800
28	45	147	3	6	-404-810	-404-810	-403-810	-403-810
30	45	147	3	6	-404-820	-404-820	-403-820	-403-820

i Na specjalne zamówienie wykonujemy narzędzia o wymiarach innych niż zawarte w tabeli / For the special order we make tools of other dimensions than contained in table / По спец. заказу производим инструменты в размерах других, чем указанные в таблице

1.1

1.2

3.1

3.2

IV

NR

DIN 845-B L-NR, DIN 845-B L-M-NR

Frezy trzpieniowe walcowo-czołowe, długie do obróbki zgrubnej z chwytem stożkowym Morse'a

Roughing end mills, long with Morse taper shank

Стержневые фрезы цилиндрическо-торцевые, длинные для черновой обработки с коническим хвостовиком Морзе

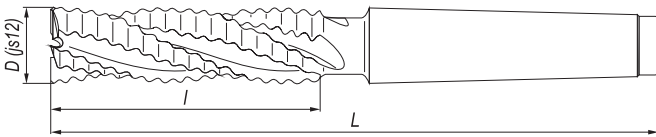

→ DIN 845-B L-M NR



→ DIN 845-B L NR

D	I	L	Nr stoż MT/HP конуса	Z	→ DIN 845-B L-M NR		→ DIN 845-B L NR	
					HSS-E index 0641-512-	HSS-E Golden Line index 0641-516-	HSS-E index 0641-512-	HSS-E Golden Line index 0641-516-
10	45	115	1	4	- 414-520	- 414-520	- 413-720	- 413-720
11	45	115	1	4	- 414-525	- 414-525	- 413-725	- 413-725
12	53	123	1	4	- 414-530	- 414-530	- 413-730	- 413-730
13	53	123	1	4	- 414-535	- 414-535	- 413-735	- 413-735
14	53	138	2	4	- 414-540	- 414-540	- 413-740	- 413-740
15	53	138	2	4	- 414-545	- 414-545	- 413-745	- 413-745
16	63	148	2	4	- 414-550	- 414-550	- 413-750	- 413-750
18	63	148	2	4	- 414-560	- 414-560	- 413-760	- 413-760
20	75	160	2	4	- 414-570	- 414-570	- 413-770	- 413-770
22	75	160	2	6	- 414-580	- 414-580	- 413-780	- 413-780
24	90	192	3	6	- 414-590	- 414-590	- 413-790	- 413-790
25	90	192	3	6	- 414-595	- 414-595	- 413-795	- 413-795
26	90	192	3	6	- 414-600	- 414-600	- 413-800	- 413-800
28	90	192	3	6	- 414-610	- 414-610	- 413-810	- 413-810
30	90	192	3	6	- 414-620	- 414-620	- 413-820	- 413-820

1.1

1.2

3.1

3.2

IV

NR

Na specjalne zamówienie wykonujemy narzędzia o wymiarach innych niż zawarte w tabeli / For the special order we make tools of other dimensions than contained in table / По спец. заказу производим инструменты в размерах других, чем указанные в таблице

DIN 844-(A,B) K&L-M-NH 50°

Frezy trzpieniowe walcowo-czołowe, krótkie i długie o ostrzach centralnych z chwytem walcowym

End mills, short and long center-cutting with straight shank

Стержневые фрезы цилиндрическо-торцевые короткие и длинные с центральными лезвиями с цилиндрическим хвостом

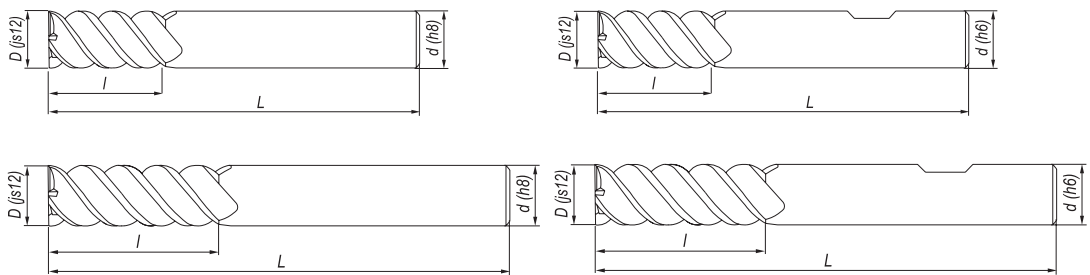
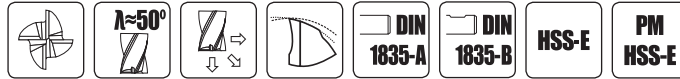

→ DIN 844-A K-M-NH 50°

D	d	l	L	HSS-E index 0641-512-	PM HSS-E index 0641-512-
6	6	13	57	-101-770	-101-970
8	10	19	69	-101-775	-101-975
10	10	22	72	-101-780	-101-980
12	12	26	83	-101-785	-101-985
14	12	26	83	-101-790	-101-990
16	16	32	92	-101-795	-101-995

→ DIN 844-A L-M-NH 50°

D	d	l	L	HSS-E index 0641-512-	PM HSS-E index 0641-512-
6	6	24	68	-111-770	-111-970
8	10	38	88	-111-775	-111-975
10	10	45	95	-111-780	-111-980
12	12	53	110	-111-785	-111-985
14	12	53	110	-111-790	-111-990
16	16	63	123	-111-795	-111-995

→ DIN 844-B K-M-NH 50° DIN 844-B L-M-NH 50° - na specjalne zamówienie/ on the special order/ по спец. заказу

i Na specjalne zamówienie wykonujemy narzędzia o wymiarach innych niż zawarte w tabeli / For the special order we make tools of other dimensions than contained in table / По спец. заказу производим инструменты в размерах других, чем указанные в таблице

2.1

2.2

IV

NH

DIN 844-(A, B) K&L-M-W

Frezy trzpieniowe walcowo-czołowe, krótkie i długie do metali lekkich z chwytem walcowym

End mills for light metals, short and long with straight shank

Стержневые фрезы цилиндрическо-торцевые, короткие и длинные для легких металлов с цилиндрическим хвостом

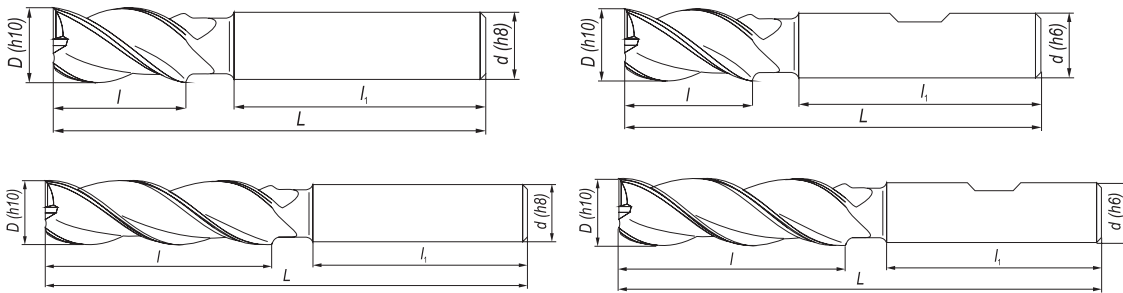

→ DIN 844-A K-M-W

D	d	l	l ₁	L	Z	HSS index 0641-512-	HSS Golden Line index 0641-516-	HSS-E index 0641-512-	HSS-E Golden Line index 0641-516-
4	6	11	36	55	3	-105-040	-105-040	-105-540	-105-540
5	6	13	36	57	3	-105-050	-105-050	-105-550	-105-550
6	6	13	36	57	3	-105-060	-105-060	-105-560	-105-560
7	10	16	40	66	3	-105-070	-105-070	-105-570	-105-570
8	10	19	40	69	3	-105-080	-105-080	-105-580	-105-580
9	10	19	40	69	3	-105-090	-105-090	-105-590	-105-590
10	10	22	40	72	3	-105-100	-105-100	-105-600	-105-600
12	12	26	45	83	3	-105-120	-105-120	-105-620	-105-620
14	12	26	45	83	3	-105-135	-105-135	-105-635	-105-635
16	16	32	48	92	3	-105-145	-105-145	-105-645	-105-645
20	20	38	50	104	4	-105-165	-105-165	-105-665	-105-665
22	20	38	50	104	4	-105-175	-105-175	-105-675	-105-675
25	25	45	56	121	4	-105-190	-105-190	-105-690	-105-690
28	25	45	56	121	4	-105-205	-105-205	-105-705	-105-705
30	25	45	56	121	4	-105-215	-105-215	-105-715	-105-715
32	32	53	60	133	4	-105-225	-105-225	-105-725	-105-725

→ DIN 844-A L-M-W

D	d	l	l ₁	L	Z	HSS index 0641-512-	HSS Golden Line index 0641-516-	HSS-E index 0641-512-	HSS-E Golden Line index 0641-516-
4	6	19	36	63	3	-115-040	-115-040	-115-540	-115-540
5	6	24	36	68	3	-115-050	-115-050	-115-550	-115-550
6	6	24	36	68	3	-115-060	-115-060	-115-560	-115-560
7	10	30	40	80	3	-115-070	-115-070	-115-570	-115-570
8	10	38	40	88	3	-115-080	-115-080	-115-580	-115-580
9	10	38	40	88	3	-115-090	-115-090	-115-590	-115-590
10	10	45	40	95	3	-115-100	-115-100	-115-600	-115-600
12	12	53	45	110	3	-115-120	-115-120	-115-620	-115-620
14	12	53	45	110	3	-115-135	-115-135	-115-635	-115-635
16	16	63	48	123	3	-115-145	-115-145	-115-645	-115-645
20	20	75	50	141	4	-115-165	-115-165	-115-665	-115-665
22	20	75	50	141	4	-115-175	-115-175	-115-675	-115-675
25	25	90	56	166	4	-115-190	-115-190	-115-690	-115-690
28	25	90	56	166	4	-115-205	-115-205	-115-705	-115-705
30	25	90	56	166	4	-115-215	-115-215	-115-715	-115-715
32	32	106	60	186	4	-115-225	-115-225	-115-725	-115-725

→ DIN 844-B (K&L)-M-W DIN 844-B (K&L)-M-W Golden Line - na specjalne zamówienie / on the special order / по спец. заказу

i Na specjalne zamówienie wykonujemy narzędzia o wymiarach innych niż zawarte w tabeli / For the special order we make tools of other dimensions than contained in table / По спец. заказу производим инструменты в размерах других, чем указанные в таблице



5.1

5.2

6

IV

W



Frezy trzpieniowe jednostrzowe do otworów odwadniających w stolarcze z PCV

Fly cutters

Стержневые фрезы с одним лезвием

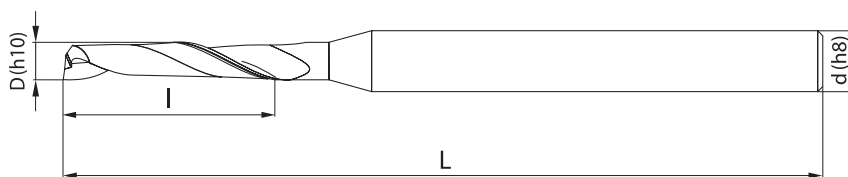

→ NFPo

D	l	L	d	HSS index 0641-519-	HSS-E index 0641-519-	D	l	L	d	HSS index 0641-519-	HSS-E index 0641-519-
3	12	60	8	-200-010	-200-510	6	25	80	8	-200-170	-200-670
4	12	60	6	-200-015	-200-515	6	14	100	8	-200-175	-200-675
4	12	60	8	-200-020	-200-520	6	40	100	8	-200-180	-200-680
4	12	80	8	-200-025	-200-525	7	14	60	8	-200-185	-200-685
4	12	100	8	-200-030	-200-530	7	14	80	8	-200-190	-200-690
4	25	100	8	-200-035	-200-535	8	14	80	8	-200-195	-200-695
4	40	100	8	-200-040	-200-540	8	25	80	8	-200-200	-200-700
4	40	120	8	-200-045	-200-545	8	40	80	8	-200-205	-200-705
5	12	60	6	-200-050	-200-550	8	14	100	8	-200-210	-200-710
5	12	60	8	-200-055	-200-555	8	25	100	8	-200-215	-200-715
5	18	60	8	-200-060	-200-560	8	40	100	8	-200-220	-200-720
5	25	70	8	-200-065	-200-565	8	14	120	8	-200-225	-200-725
5	14	80	8	-200-070	-200-570	8	25	120	8	-200-230	-200-730
5	25	80	8	-200-075	-200-575	8	40	120	8	-200-235	-200-735
5	35	80	8	-200-080	-200-580	9	14	80	8	-200-240	-200-740
5	25	90	8	-200-085	-200-585	9	40	100	8	-200-245	-200-745
5	35	90	8	-200-090	-200-590	10	14	80	8	-200-250	-200-750
5	16	100	8	-200-100	-200-600	10	14	100	8	-200-255	-200-755
5	20	100	8	-200-105	-200-605	10	22	100	8	-200-260	-200-760
5	25	100	8	-200-110	-200-610	10	14	80	10	-200-265	-200-765
5	30	100	8	-200-115	-200-615	10	25	90	10	-200-270	-200-770
5	35	100	8	-200-120	-200-620	10	14	100	10	-200-275	-200-775
5	40	100	8	-200-125	-200-625	10	45	100	10	-200-280	-200-780
5	45	100	8	-200-130	-200-630	10	14	120	10	-200-285	-200-785
5	16	120	8	-200-140	-200-640	10	45	120	10	-200-290	-200-790
5	40	120	8	-200-145	-200-645	11	14	80	8	-200-295	-200-795
6	14	60	6	-200-150	-200-650	12	14	80	8	-200-300	-200-800
6	14	60	8	-200-155	-200-655	12	50	90	8	-200-305	-200-805
6	25	70	8	-200-160	-200-660	12	28	100	8	-200-310	-200-810
6	14	80	8	-200-165	-200-665	12	14	80	10	-200-315	-200-815
>>	>>	>>	>>	>>	>>						

i Na specjalne zamówienie wykonujemy narzędzia o wymiarach innych niż zawarte w tabeli / For the special order we make tools of other dimensions than contained in table / По спец. заказу производим инструменты в размерах других, чем указанные в таблице

5.1

5.2

6

IV

W

NFPv, NFPj

NFPv

Frezy trzpieniowe jednostrzowe z czołem Drill Point 90° *

Waterslot cutters with Drill Point 90° *

Стержневые фрезы с одним лезвием и торцом Drill Point 90° *

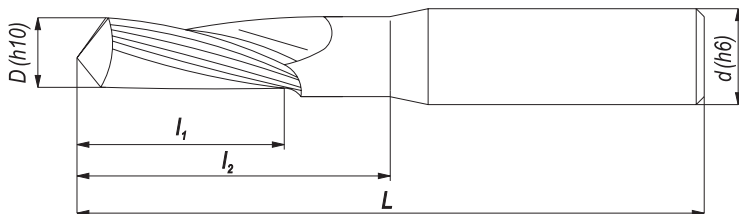

→ NFPv

D	l ₁	l ₂	L	d	index 0641-512-
5	40	-	80	5	-800-510
5	20	-	60	8	-800-515
5	30	-	80	8	-800-520
5	40	-	80	8	-800-525
5	35	55	90	8	-800-530
5	35	55	100	8	-800-535
6	40	-	80	6	-800-540
6	35	72	110	8	-800-545



* Na specjalne zamówienie (termin realizacji ~2 tygodnie) / On the special order (delivery time ~2 weeks) / По спец. заказам (срок реализации ~2 недели)

NFPj

Frezy trzpieniowe jednostrzowe do metali lekkich i tworzyw sztucznych – uniwersalne

Fly cutters for light metals and plastics, universal

Стержневые фрезы с 1-лезвием для легких металлов и пластмасс – универсальные

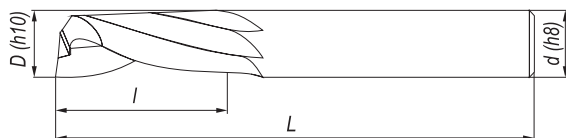

→ NFPj

D	d	l	L	HSS-E index 0641-519-	HSS-E Golden Line index 0641-520-
6	6	20	57	-105-520	-105-520
8	8	22	63	-105-525	-105-525
10	10	25	72	-105-530	-105-530
12	12	30	83	-105-535	-105-535



Na specjalne zamówienie wykonujemy narzędzia o wymiarach innych niż zawarte w tabeli / For the special order we make tools of other dimensions than contained in table / По спец. заказу производим инструменты в размерах других, чем указанные в таблице



5.1

5.2

6

IV

W