



# EXACT

Production Cordless & Electric Screwdrivers

[www.boschproductiontools.com](http://www.boschproductiontools.com)



**BOSCH**  
Invented for life

# Big features, small package.

C-EXACT



**Bright LED Lighting** for work area illumination

**Snap-in Color Rings** for easy identification

**One Handed Forward/Reverse Control**

ANGLE  
EXACT!

SEC-ANGLE  
EXACT!



**Repeat Protection**

**Lightweight, Balanced Design** for better ergonomics

**Industrial Battery Design** for best durability

**Torque Adjustment** using special tool

**Highest Repeatability** via Bosch clutch design

EXACT

SEC-EXACT



**Easy Service** with plug connectors and common service parts

**Bosch SEC-Motor** brushless motor technology

**Battery Indicator** with low voltage tool lockout

**Joint Control Indicator** provides operator feedback

**Cordless Error Proofing** via Bluetooth wireless system

<b>E</b>	<b>X</b>	<b>A</b>	<b>C</b>	<b>T</b>
Ergonomic	EXtremely Light	Accurate	Cmk proven	Tool

## CE Conformity

All electric, measuring and pneumatic power tools listed in this catalogue comply with the following standards: EN 60745, EN 50144, EN 61029, EN 60335-1, EN 60825-1 or EN 792 (depending on the model), EN 55014, EN 61000-3-2, -3-3 or -3-11 according to the provisions of EU Directives 2006/95/EC, 98/37/EC (until 28.12.2009), 2006/42/EC (as of 29.12.2009), 2004/108/EC.



**Certified in  
accordance with  
ISO 9001**

**Certificate no.: FM 30078**

# Table of contents

2	Common product features
4	Online production tool support
<b>6</b>	<b>Production Electric Screwdrivers</b>
8	C-EXACT electric screwdriver
10	PUC-EXACT power supply
<b>12</b>	<b>Production Cordless Screwdrivers</b>
16	EXACT Cordless centre-grip screwdrivers
18	ANGLE EXACT cordless nutrunners
20	ANGLE EXACT CF cordless nutrunners
<b>22</b>	<b>Bluetooth error proofing Cordless Screwdrivers</b>
26	Tool management software
28	EXAConnect wireless controller
29	Bluetooth digital I/O module
30	BT-EXACT cordless centre-grip screwdrivers
32	BT-ANGLE EXACT cordless nutrunners
<b>34</b>	<b>The new generation of SEC-EXACT Cordless Screwdrivers</b>
38	SEC-EXACT cordless center-grip screwdrivers
40	SEC-ANGLE EXACT cordless nutrunners
<b>42</b>	<b>Accessories</b>
44	Smart battery chargers
45	Production batteries
46	4-EXACT Power Supply
47	Accessories and dimensions

## New products







# An overview with a single click:

All production tools online.



An extensive online catalog including product applications is available at [www.boschproductiontools.com](http://www.boschproductiontools.com).

The tool selection is made easier by the ability to run comparisons between tools. For example, users can create a display of all air screwdrivers/wrenches and compare data such as power output or rpm.

Furthermore, they find the latest news about measurement data, innovations and new developments from Bosch Production Tools. Users are quickly given all relevant information needed to select the correct production tools.

Operating instructions, pictures and exploded drawings can be downloaded directly from the Internet.

A spare parts service informs users about which spare parts they need – and where they can order them.







**Hopefully, you will not**  
run out of screws.

C-EXACT and PUC-EXACT.  
The Industrial Screwdriver System from Bosch.

# Never lets you down, even after 1 million screws

The new C-EXACT electric screwdrivers offer much more than just a tough polyamide housing. High accuracy and repeatability are guaranteed, even after driving 1 million\* screws.

## Durable, efficient and user-friendly

Combining low-voltage operation, brushless DC motor technology and key components from the EXACT cordless screwdriver line, the new C-EXACT electric screwdrivers provide a cost-effective tool packed with innovative features. The clutch provides 15% greater torque in reverse for loosening fasteners, if needed. A special tool adjusts the clutch; storing the adjusting tool away from the end user prevents changing of torque settings. Various snap-in color rings attach to the nose of the tool to allow users to quickly identify various torque range settings at the assembly line.

## Precise and stable under load

Whether assembling computer drives, electronics or precision mechanical equipment, the C-EXACT is a great choice when precision is what matters most.

Bosch quality testing for the C-EXACT family is extremely rigorous. Each C-EXACT must survive a 1,000,000 cycle test under load without failure or excessive adjustment before being released for production. Standard operational life must exceed 1,000,000 cycles while maintaining a minimum ISO 5393 standard CMK value greater than

1.67 with a tolerance of  $\pm 10\%$ . Our electric tools are among the most accurate on the planet.

## The C-EXACT straight screwdriver

The C-EXACT is the first in a new family of straight electric drivers from Bosch. It is equipped with a combination of great features to insure that it sets new standards for accuracy and durability.

- ▶ Brushless DC electric motor
- ▶ One-handed forward/reverse
- ▶ ESD (ElectroStatic Discharge) compliant

## The PUC-EXACT power supply

The C-EXACT electric screwdriver uses a single PUC-EXACT power supply to provide clean, quiet energy to the brushless DC electric motor.

The PUC-EXACT comes with a 3 meter long power cable to give you a power source that can be located where you need it. The power supply helps lower operating costs by providing the tool with efficient low-voltage electricity.

The new C-EXACT (corded EXACT with 3.5 Nm, or 31 in/lbs of maximum torque) electric screwdrivers are available as a lever start or push start driver.

The PUC-EXACT power supply safely generates the low-voltage electricity needed for efficient operation.



\* Results from Bosch endurance tests









ElectroStatic Discharge (ESD) compliant means the tool is ideal for use in the electronics and electrical industries.



# C-EXACT

## Electric screwdriver



- ▶ Rugged and durable  
Bosch endurance test for over one million cycles
- ▶ Bosch SEC motor  
All models feature brushless motor technology
- ▶ High shut-off accuracy with very low tolerance
- ▶ Broad torque range
- ▶ Optic and acoustic signals for shut off

	Order number	Torque on hard joint per ISO 5393 (Nm)	Torque on soft joint per ISO 5393 (Nm)
<b>Electric screwdrivers C-EXACT 1</b>	0 602 495 202	0.2 – 0.8 (1.8 – 7.1 in.-lbs.)	0.2 – 0.8 (1.8 – 7.1 in.-lbs.)
	0 602 495 207	0.2 – 0.8 (1.8 – 7.1 in.-lbs.)	0.2 – 0.8 (1.8 – 7.1 in.-lbs.)
<b>Electric screwdrivers C-EXACT 2</b>	0 602 495 203	0.5 – 2 (4.4 – 17.7 in.-lbs.)	0.5 – 2 (4.4 – 17.7 in.-lbs.)
	0 602 495 208	0.5 – 2 (4.4 – 17.7 in.-lbs.)	0.5 – 2 (4.4 – 17.7 in.-lbs.)
<b>Electric screwdrivers C-EXACT 4</b>	0 602 495 200	0.5 – 3.5 (4.4 – 31 in.-lbs.)	0.5 – 3.5 (4.4 – 31 in.-lbs.)
	0 602 495 201	US version of 0 602 495 200	
	0 602 495 205	0.5 – 3.5 (4.4 – 31 in.-lbs.)	0.5 – 3.5 (4.4 – 31 in.-lbs.)
	0 602 495 206	US version of 0 602 495 205	

# PUC-EXACT

## Power supply

- ▶ Robust and durable design
- ▶ Indicators for power and overload
- ▶ Available in a single and triple connector version
- ▶ Built-in thermostatically controlled cooling fan

	Order number	Input voltage (V)	Input frequency (Hz)
<b>Power supply PUC-EXACT 1</b>	0 602 495 001	100 – 240 AC	50 – 60
	0 602 495 002	100 – 240 AC	50 – 60
<b>Power supply PUC-EXACT 3</b>	0 602 495 003	100 – 240 AC	50 – 60
			

**C-EXACT****EXACT****BT-EXACT****SEC-EXACT****ACCESSORIES**

Speed (rpm)	Voltage (V)	Power (W)	Rotation direction	Weight (kg / lbs)	Features	Included accessories
1000	36 DC	360	R/L	0.65 / 1.4	Lever start	2.5 meter / 8.2 ft. long cable suspension hook green color ring torque adjustment tool
1000	36 DC	360	R/L	0.65 / 1.4	Push start	
500	36 DC	360	R/L	0.65 / 1.4	Lever start	2.5 meter / 8.2 ft. long cable suspension hook white color ring torque adjustment tool
500	36 DC	360	R/L	0.65 / 1.4	Push start	
1000	36 DC	360	R/L	0.65 / 1.4	Lever start	2.5 meter / 8.2 ft. long cable suspension hook grey color ring torque adjustment tool
1000	36 DC	360	R/L	0.65 / 1.4	Push start	

Power consumption (W)	Output voltage (V)	Features	Included accessories
400	36 DC	Power supply for one C-EXACT	3 meter / 9.8 ft. power cable European plug
400	36 DC	Power supply for one C-EXACT US-version	3 meter / 9.8 ft. power cable American plug
400	36 DC	Power supply for three C-EXACT	3 meter / 9.8 ft. power cable European plug









## Cordless assembly with incredible precision.

EXACT and ANGLE EXACT Bosch Production Cordless Screwdrivers are incredibly accurate, durable and energy-efficient. In fastener locations where cables or pneumatic hoses would get in the way, the standard EXACT tools give you the ability to build better products, improve worker safety, and lower your costs.

# Shut-off clutch

## proven for industry.

Our shut-off clutch is designed to minimize user influence on the fastening process. Bosch clutches are among the most repeatable and accurate in the world. Our repeatability rivals that of some DC smart tools costing thousands more than our EXACT cordless tools.

### Precise, accurate shut-off

The EXACT clutch ensures high torque repeatability and accuracy. Whether in a hard joint application of 30 degrees or a soft joint of 720 degrees, the clutch guarantees an extremely low mean value offset and consistent torque. Clutch quality conforms to ISO 5393 requirements.

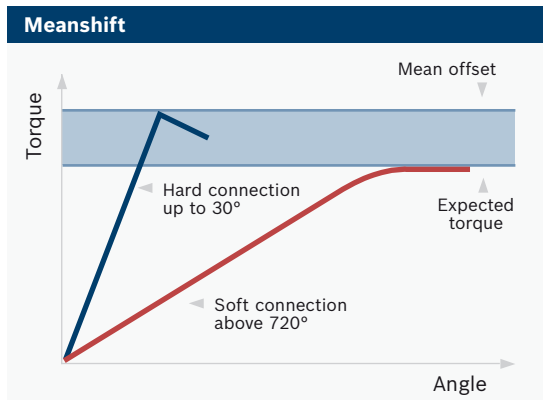

### User-friendly features

The EXACT clutch provides 15% greater torque in reverse for loosening fasteners, when needed. Specified torque is always reached regardless of battery voltage; the microprocessor prevents the tool from running if the battery falls below a minimum threshold voltage.

A special tool adjusts the clutch; storing the adjusting tool away from the end user prevents changing of torque settings. Various snap-in color rings attach to the nose of the tool to allow users to quickly identify various torque range settings at the assembly line.

### Precise and stable under load

Bosch quality testing for the EXACT family is extremely rigorous. Each version of EXACT must survive a 500,000 cycle test under load without failure or excessive adjustment before being released for production. Standard operational life must exceed 500,000 cycles while maintaining a minimum ISO 5393 standard CMK value greater than 1.67 with a tolerance of  $\pm 10\%$  in a range of 0.6 to 30 Newton-meters.

### A proven performer

The shut-off clutch used in the EXACT cordless family is the identical clutch used in our line of production air tools. This clutch has been used in hundreds of applications over the years and is a proven performer at many of our customers' facilities.

Capability study of the  
ANGLE EXACT 15

















The Bosch EXACT and ANGLE EXACT cordless shut-off screwdrivers fit every application!



# EXACT

## Centre-grip cordless screwdrivers

- ▶ Precision Shut-off clutch exceeds ISO tolerance of ±10%
- ▶ Lightweight
- ▶ Broad torque range
- ▶ Trigger repeat protection
- ▶ LED/audible battery charge indicators disable tool when voltage drops below threshold; tool stays “in-process” regardless of battery condition
- ▶ LED/audible shut-off indicator provides operator feedback for clutch signal to confirm good/bad joint status
- ▶ Bright LED light for work area illumination
- ▶ All models feature trigger hand forward/reverse control
- ▶ Tools share many common parts
- ▶ Color rings are used to identify joint types on the assembly line
- ▶ Protective rubber cover available for quick-change bit holder
- ▶ Tool holding fixtures available
- ▶ All models can be hung from balancer using accessory hook

EXACT	Order number	Torque on hard joint per ISO 5393 (Nm)	Torque on soft joint per ISO 5393 (Nm)
<b>EXACT 2</b> very precise in the lower torque range 	0 602 490 433	0.6 – 2 (0.4 – 1.5 ft.-lbs.)	0.6 – 2 (0.4 – 1.5 ft.-lbs.)
	0 602 490 460	(US version of 0 602 490 433)	
	0 602 490 434	0.6 – 2 (0.4 – 1.5 ft.-lbs.)	0.6 – 2 (0.4 – 1.5 ft.-lbs.)
	0 602 490 450	(US version of 0 602 490 434)	
<b>EXACT 4</b> high speed for short cycle times 	0 602 490 437	1 – 4 (0.7 – 3 ft.-lbs.)	1 – 4 (0.7 – 3 ft.-lbs.)
	0 602 490 461	(US version of 0 602 490 437)	
	0 602 490 438	1 – 4 (0.7 – 3 ft.-lbs.)	1 – 4 (0.7 – 3 ft.-lbs.)
	0 602 490 451	(US version of 0 602 490 438)	
<b>EXACT 6</b> combination of speed and torque 	0 602 490 431	1 – 6 (0.7 – 4.4 ft.-lbs.)	1 – 6 (0.7 – 4.4 ft.-lbs.)
	0 602 490 462	(US version of 0 602 490 431)	
	0 602 490 432	1 – 6 (0.7 – 4.4 ft.-lbs.)	1 – 6 (0.7 – 4.4 ft.-lbs.)
	0 602 490 452	(US version of 0 602 490 432)	
<b>EXACT 7</b> slow screwdriver e.g. for hose clamps 	0 602 490 439	1.5 – 7 (1.1 – 5.2 ft.-lbs.)	1.5 – 7 (1.1 – 5.2 ft.-lbs.)
	0 602 490 464	(US version of 0 602 490 439)	
	0 602 490 440	1.5 – 7 (1.1 – 5.2 ft.-lbs.)	1.5 – 7 (1.1 – 5.2 ft.-lbs.)
	0 602 490 454	(US version of 0 602 490 440)	
<b>EXACT 8</b> power speed 	0 602 490 443	1.5 – 8 (1.1 – 5.9 ft.-lbs.)	1.5 – 8 (1.1 – 5.9 ft.-lbs.)
	0 602 490 466	(US version of 0 602 490 443)	
	0 602 490 444	1.5 – 8 (1.1 – 5.9 ft.-lbs.)	1.5 – 8 (1.1 – 5.9 ft.-lbs.)
	0 602 490 456	(US version of 0 602 490 444)	
<b>EXACT 9</b> high torque with low weight 	0 602 490 435	1.5 – 9 (1.1 – 6.7 ft.-lbs.)	1.5 – 9 (1.1 – 6.7 ft.-lbs.)
	0 602 490 463	(US version of 0 602 490 435)	
	0 602 490 436	1.5 – 9 (1.1 – 6.7 ft.-lbs.)	1.5 – 9 (1.1 – 6.7 ft.-lbs.)
	0 602 490 453	(US version of 0 602 490 436)	
<b>EXACT 12</b> highest torques 	0 602 490 441	1.5 – 12 (1.1 – 9 ft.-lbs.)	1.5 – 12 (1.1 – 9 ft.-lbs.)
	0 602 490 467	(US version of 0 602 490 441)	
	0 602 490 442	1.5 – 12 (1.1 – 9 ft.-lbs.)	1.5 – 12 (1.1 – 9 ft.-lbs.)
	0 602 490 457	(US version of 0 602 490 442)	
<b>EXACT 60</b> extremely slow speeds below 100 rpm 	0 602 490 469	1.5 – 5.5 (1.1 – 4.1 ft.-lbs.)	1.5 – 5.5 (1.1 – 4.1 ft.-lbs.)
	0 602 490 470	1.5 – 5.5 (1.1 – 4.1 ft.-lbs.)	1.5 – 5.5 (1.1 – 4.1 ft.-lbs.)
<b>EXACT 700</b> high speed and high torque 	0 602 490 447	1.5 – 8 (1.1 – 5.9 ft.-lbs.)	1.5 – 8 (1.1 – 5.9 ft.-lbs.)
<b>EXACT 1100</b> highest speed 	0 602 490 445	1 – 4 (0.7 – 3 ft.-lbs.)	1 – 4 (0.7 – 3 ft.-lbs.)
	0 602 490 446	1 – 4 (0.7 – 3 ft.-lbs.)	1 – 4 (0.7 – 3 ft.-lbs.)

C-EXACT

EXACT

BT-EXACT

SEC-EXACT

ACCESSORIES







No-load speed (min <sup>-1</sup> )	Bit holder	Battery specifications	Direction of rotation	Weight (kg / lbs)	Features	Included accessories
600	¼"	–	R/L	0.8 / 1.76	0.7 repeat protection	Torque adjustment tool light green color ring
600	¼"	9.6 V / 1.7 Ah	R/L	1.2 / 2.6	0.7 repeat protection	
900	¼"	–	R/L	0.8 / 1.76	0.7 repeat protection	Torque adjustment tool grey color ring
900	¼"	9.6 V / 1.7 Ah	R/L	1.2 / 2.6	0.7 repeat protection	
600	¼"	–	R/L	0.8 / 1.76	0.7 repeat protection	Torque adjustment tool black color ring
600	¼"	9.6 V / 1.7 Ah	R/L	1.2 / 2.6	0.7 repeat protection	
150	¼"	–	R/L	0.8 / 1.76	0.7 repeat protection	Torque adjustment tool white color ring
150	¼"	9.6 V / 1.7 Ah	R/L	1.2 / 2.6	0.7 repeat protection	
650	¼"	–	R/L	0.9 / 2.0	0.7 repeat protection	Torque adjustment tool orange color ring
650	¼"	12 V / 2.4 Ah	R/L	1.6 / 3.5	0.7 repeat protection	
350	¼"	–	R/L	0.8 / 1.76	0.7 repeat protection	Torque adjustment tool light blue color ring
350	¼"	9.6 V / 1.7 Ah	R/L	1.2 / 2.6	0.7 repeat protection	
400	¼"	–	R/L	0.9 / 2.0	0.7 repeat protection	Torque adjustment tool red color ring
400	¼"	12 V / 2.4 Ah	R/L	1.6 / 3.5	0.7 repeat protection	
60	¼"	–	R/L	0.8 / 1.76	0.7 repeat protection	Torque adjustment tool white color ring
60	¼"	9.6 V / 1.7 Ah	R/L	1.2 / 2.6	0.7 repeat protection	
700	¼"	– (Not included)	R/L	0.9 / 2.0	0.7 repeat protection	Torque adjustment tool orange color ring
1100	¼"	–	R/L	0.8 / 1.76	0.7 repeat protection	Torque adjustment tool grey color ring
1100	¼"	9.6 V / 1.7 Ah	R/L	1.2 / 2.6	0.7 repeat protection	



# ANGLE EXACT

## Cordless nutrunners

- ▶ Precision Shut-off clutch exceeds ISO tolerance of  $\pm 10\%$
- ▶ Lightweight
- ▶ Broad torque range
- ▶ Trigger repeat protection
- ▶ LED/audible battery charge indicator; same as T-grip
- ▶ LED/audible shut-off indicator; same as T-grip
- ▶ Bright LED light for work area illumination
- ▶ All models feature trigger hand forward/reverse control
- ▶ Tools share many common parts
- ▶ Color rings are used to identify joint types on the assembly line
- ▶ Protective rubber cover available for angle heads
- ▶ Uses same batteries/chargers as T-Grip models
- ▶ All models can be hung from balancer using suspension hook
- ▶ Tool weight with angle head and battery is 1.6kg/3.5 lbs

	Order number	Torque on hard joint per ISO 5393 (Nm)	Torque on soft joint per ISO 5393 (Nm)
<b>ANGLE EXACT 2</b> low torques and low speed: suitable for titanium screws 	0 602 490 647	0.7 – 2 (0.5 – 1.5 ft.-lbs.)	0.7 – 2 (0.5 – 1.5 ft.-lbs.)
<b>ANGLE EXACT 3</b> very precise in the lower torque range 	0 602 490 656	0.7 – 3 (0.5 – 2.2 ft.-lbs.)	0.7 – 3 (0.5 – 2.2 ft.-lbs.)
<b>ANGLE EXACT 7</b> very low speed: suitable for titanium screws 	0 602 490 669	2 – 7 (1.5 – 5.1 ft.-lbs.)	2 – 7 (1.5 – 5.1 ft.-lbs.)
<b>ANGLE EXACT 6</b> high speed 	0 602 490 639	1.5 – 6 (1.1 – 4.4 ft.-lbs.)	1.5 – 6 (1.1 – 4.4 ft.-lbs.)
	0 602 490 640	1.5 – 6 (1.1 – 4.4 ft.-lbs.)	1.5 – 6 (1.1 – 4.4 ft.-lbs.)
	0 602 490 641	1.5 – 6 (1.1 – 4.4 ft.-lbs.)	1.5 – 6 (1.1 – 4.4 ft.-lbs.)
	0 602 490 642	1.5 – 6 (1.1 – 4.4 ft.-lbs.)	1.5 – 6 (1.1 – 4.4 ft.-lbs.)
	0 602 490 652	1.5 – 6 (1.1 – 4.4 ft.-lbs.)	1.5 – 6 (1.1 – 4.4 ft.-lbs.)
<b>ANGLE EXACT 8</b> combination of speed and torque 	0 602 490 637	2 – 9 (1.5 – 6.7 ft.-lbs.)	2 – 8 (1.5 – 5.9 ft.-lbs.)
	0 602 490 638	2 – 9 (1.5 – 6.7 ft.-lbs.)	2 – 8 (1.5 – 5.9 ft.-lbs.)
	0 602 490 643	2 – 9 (1.5 – 6.7 ft.-lbs.)	2 – 8 (1.5 – 5.9 ft.-lbs.)
	0 602 490 644	2 – 9 (1.5 – 6.7 ft.-lbs.)	2 – 8 (1.5 – 5.9 ft.-lbs.)
	0 602 490 651	2 – 9 (1.5 – 6.7 ft.-lbs.)	2 – 8 (1.5 – 5.9 ft.-lbs.)
<b>ANGLE EXACT 15</b> high torque with very low weight 	0 602 490 635	2 – 15 (1.5 – 11 ft.-lbs.)	2 – 15 (1.5 – 11 ft.-lbs.)
	0 602 490 636	2 – 15 (1.5 – 11 ft.-lbs.)	2 – 15 (1.5 – 11 ft.-lbs.)
	0 602 490 650	2 – 15 (1.5 – 11 ft.-lbs.)	2 – 15 (1.5 – 11 ft.-lbs.)

C-EXACT

EXACT

BT-EXACT

SEC-EXACT





ACCESSORIES

No-load speed (min <sup>-1</sup> )	Angle head	Battery specifications	Direction of rotation	Weight (kg / lbs)	Features	Included accessories
110	–	–	R/L	1.0	0.7 repeat protection	Torque adjustment tool Housing wrench Suspension hook light-green color ring
420	–	–	R/L	1.0	0.7 repeat protection	Torque adjustment tool Housing wrench Suspension hook light-green color ring
110	–	–	R/L	1.0	0.7 repeat protection	Torque adjustment tool Housing wrench Suspension hook orange color ring
650	1/4" internal hexagon	–	R/L	1.2	0.7 s restart protection	Torque adjustment tool Housing wrench Suspension hook black color ring
650	1/4" internal hexagon	9.6 V / 1.7 Ah	R/L	1.6	0.7 s restart protection	
650	1/4" square	–	R/L	1.2	0.7 s restart protection	
650	1/4" square	9.6 V / 1.7 Ah	R/L	1.6	0.7 s restart protection	
650	–	–	R/L	1.0	0.7 s restart protection	
420	3/8" square	–	R/L	1.2	0.7 s restart protection	Torque adjustment tool Housing wrench Suspension hook orange color ring
420	3/8" square	9.6 V / 1.7 Ah	R/L	1.6	0.7 s restart protection	
420	1/4" square	–	R/L	1.2	0.7 s restart protection	
420	1/4" square	9.6 V / 1.7 Ah	R/L	1.6	0.7 s restart protection	
420	–	–	R/L	1.0	0.7 s restart protection	
250	3/8" square	–	R/L	1.2	0.7 s restart protection	Torque adjustment tool Housing wrench Suspension hook red color ring
250	3/8" square	9.6 V / 1.7 Ah	R/L	1.6	0.7 s restart protection	
250	–	–	R/L	1.0	0.7 s restart protection	

# ANGLE EXACT

## Cordless nutrunners





- ▶ See page 18 for features
- ▶ Tool weight with angle head and battery is 2.6kg/5.7 lbs

	Order number	Torque on hard joint per ISO 5393 (Nm)	Torque on soft joint per ISO 5393 (Nm)
<b>ANGLE EXACT 17</b> high speed	0 602 490 675	6 – 17 (4.4 – 12.5 ft-lbs)	6 – 13 (4.4 – 9.6 ft-lbs)
	0 602 490 676	6 – 17 (4.4 – 12.5 ft-lbs)	6 – 13 (4.4 – 9.6 ft-lbs)
<b>ANGLE EXACT 23</b> good torque & speed	0 602 490 673	7 – 23 (5.1 – 17 ft-lbs)	0.7 – 3 (5.1 – 14.8 ft-lbs)
	0 602 490 674	7 – 23 (5.1 – 17 ft-lbs)	0.7 – 3 (5.1 – 14.8 ft-lbs)
<b>ANGLE EXACT 30</b> high torque	0 602 490 671	8 – 30 (5.9 – 22.1 ft-lbs)	8 – 28 (5.9 – 20.7 ft-lbs)
	0 602 490 672	8 – 30 (5.9 – 22.1 ft-lbs)	8 – 28 (5.9 – 20.7 ft-lbs)

# ANGLE EXACT CF

## Cordless nutrunners

The ANGLE EXACT CF models are designed for specialty crowfoot or tube nut heads not manufactured by Bosch. The CF models perform the same as standard models in forward, but limit power & run time in reverse to prevent head damage.

	Order number	Torque on hard joint per ISO 5393 (Nm)	Torque on soft joint per ISO 5393 (Nm)
<b>ANGLE EXACT 14 CF</b> high speed	0 602 490 690	1.4 – 10 (1 – 7.4 ft-lbs ) (w/o head)	1.4 – 10 (1 – 7.4 ft-lbs ) (w/o head)
			
<b>ANGLE EXACT 22 CF</b> good torque & speed	0 602 490 693	5 – 16 (3.7 – 12 ft-lbs) (w/o head)	5 – 14.3 (3.7 – 10.5 ft-lbs) (w/o head)
			
<b>ANGLE EXACT 29 CF</b> high torque	0 602 490 691	5.7 – 21 (4.2 – 15.4 ft-lbs) (w/o head)	5.7 – 20 (4.2 – 14.8 ft-lbs) (w/o head)
			



C-EXACT	<b>EXACT</b>	BT-EXACT	SEC-EXACT	ACCESSORIES
---------	--------------	----------	-----------	-------------

No-load speed (min <sup>-1</sup> )	Angle head	Battery specifications	Direction of rotation	Weight (kg / lbs)	Features	Included accessories
560	–	–	R/L	2.4 / 5.3	0.7 repeat protection	Torque adjustment tool Housing wrench Suspension hook white color ring
560	–	14.4 V / 2.4 Ah	R/L	1.5 / 3.3	0.7 repeat protection	
320	–	–	R/L	2.4 / 5.3	0.7 repeat protection	Torque adjustment tool Housing wrench Suspension hook orange color ring
320	–	14.4 V / 2.4 Ah	R/L	1.5 / 3.3	0.7 repeat protection	
220	– requires HD angle head	–	R/L	2.4 / 5.3	0.7 repeat protection	Torque adjustment tool Housing wrench Suspension hook red color ring
220	– requires HD angle head	14.4 V / 2.4 Ah	R/L	1.5 / 3.3	0.7 repeat protection	

No-load speed (min <sup>-1</sup> )	Angle head	Battery specifications	Direction of rotation	Weight (kg / lbs)	Features	Included accessories
350 (w/o head)	Custom head not supplied by Bosch	9.6 V (Not included)	R/L	1.0 / 2.2	0.7 repeat protection  Same specifications as ANGLE EXACT 15 in forward; reduced power in reverse	Torque adjustment tool Housing wrench Suspension hook red color ring
440 (w/o head)	Custom head not supplied by Bosch	14.4 V (Not included)	R/L	1.5 / 3.3	0.7 repeat protection  Same specifications as ANGLE EXACT 23 in forward; reduced power in reverse	Torque adjustment tool Housing wrench Suspension hook orange color ring
300 (w/o head)	Custom head not supplied by Bosch	14.4 V (Not included)	R/L	1.5 / 3.3	0.7 repeat protection  Same specifications as ANGLE EXACT 30 in forward; reduced power in reverse	Torque adjustment tool Housing wrench Suspension hook red color ring





## Are you sure there are no loose screws here?

The Bluetooth EXACT Cordless Screwdriving system thinks for itself. The BT-EXACT tool takes its commands from the EXAConnect controller, which stores the work in progress in real time. The system can talk to and take commands from external devices like a PLC, bar code scanner or host network if desired. Improve your assembly process and never miss another fastener.



# Error-proofing for cordless assembly tools: Build it better with Bluetooth EXACT.

The Bluetooth EXACT Cordless Screwdriving system thinks for itself. The BT-EXACT tool takes its commands from the EXACConnect controller, which stores the work in progress in real time. The system can talk to and take commands from external devices like a PLC, bar code scanner or host network if desired. Improve your assembly process and never miss another fastener.

Wireless OK/NOK (joint ok or not ok) signals are sent from the BT-EXACT Screwdriver to the EXACConnect controller, which also sends commands back to the tool. A class 2 Bluetooth module guarantees data transfer without compromise using 56-bit encryption and level 3 security in Bluetooth standard 1.2. The tools and controller communicate only with each other. The software can be configured to actively block Bosch Bluetooth signals from disturbing a wireless LAN, preventing data loss in other wireless networks in an assembly plant. An adjustable antenna power output function allows the system to limit electromagnetic “pollution” to virtually nothing. One EXACConnect controller can run seven tools simultaneously, making the system very cost-effective.

Bar code scanners, PLC’s, stack lights and host network systems can be easily connected to the EXACConnect via a combination of built-in I/O ports, RS 422 ports and Ethernet connections. The system can also run as a stand-alone without additional hardware. An anti-theft system prevents the tool from operating out of range of the EXACConnect.

The system is unique compared to other products; it does not require software to communicate with a network or computer. All information in the EXACConnect controller is accessed by using a web browser. All software and firmware is stored within the EXACConnect controller. The system is completely self-diagnostic.

## **The Bosch Bluetooth system: Quality control redefined.**

The EXACConnect can control a BT-EXACT tool by workpiece, fastener and batch count. The OK/NOK signal can be enhanced (if desired) using run time and other parameters to accurately determine cross-threading of fasteners or missing assembly parts; it can detect and limit direction of rotation to prevent fastener removal. Over 50 different counting and work/rework strategies can be programmed.

The system can be set to count a batch of fasteners per job, or report single fastener data. It can control the assembly line to insure that a worker correctly tightens the right fastener on the right part at the right time. Three LED lights on the BT-EXACT tool tell the worker battery status, if the fastener was properly tightened, and if the tool is locked, unlocked or out of range of the EXACConnect. The system collects and reports all this data to insure that your assembly process is always perfect.





# Seven screwdrivers at a single glance: Powerful tool management software.

Quality control should be easy, not complicated. Our software combines powerful control, great flexibility and easy-to-use programming to give you the capability to control the BT-EXACT tools, the EXAConnect controller and your assembly line from anywhere.

The system runs in a web browser without the need for expensive user interface software. It can be password-protected to insure process security. Take control of data going to and from the screwdrivers, the controller and your network in a whole new way.

Clicking on the overview tab lets you view & control up to seven BT-EXACT drivers running on one EXAConnect controller. Each tool displays antenna signal strength, battery status, screw count, batch status and joint condition (OK/NOK shown in green or red).

The serial number and name of each tool is also displayed. The name of each tool can be customized for specific applications or locations within the assembly process.



Clicking on the EXAConnect tab shows the detailed data for up to seven tools in real time. The system can display data such as driver name, date, time of event, screw run time, direction of rotation, error messages, screw count, batch count and additional input data (like bar code scans or sequence numbers).

The system also displays the status of the EXAConnect controller and lists the devices that are connected. System error messages are displayed here, along with detailed information about the configuration.

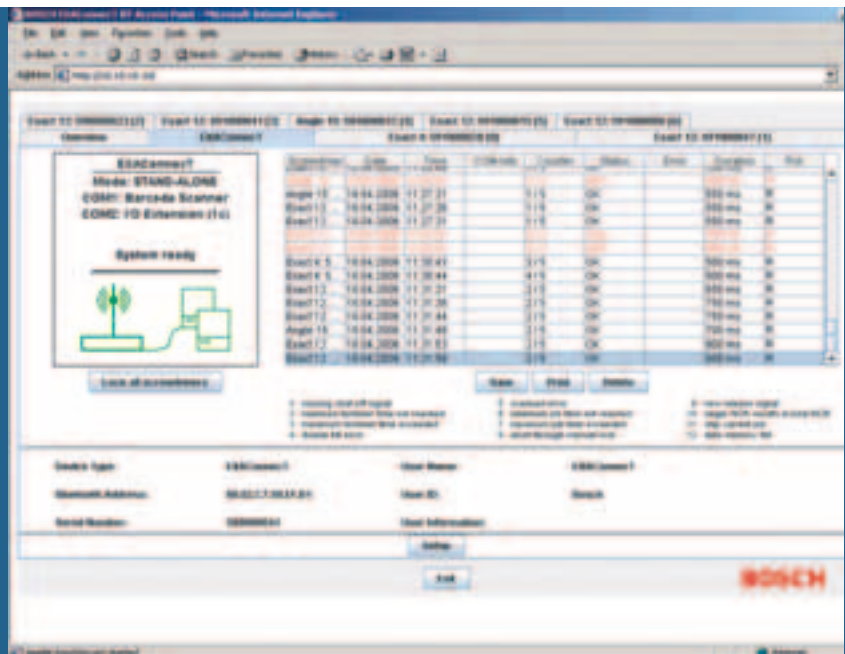



# Fine tuning for seven precision instruments: A symphony of data control

Setup of the system is easy. All functions of the EXACConnecT controller are programmed from only one user-friendly setup screen. Standard protocols including Profibus, Ethernet TCP/IP, DeviceNet, FTP servers, serial ports, stack lights and RS 422 ports are managed in one place. Each individual BT-EXACT tool

can be programmed to send data to different outputs simultaneously. Each tool can accept data from a variety of inputs. All this capability is managed by only one setup screen for each BT-EXACT tool.

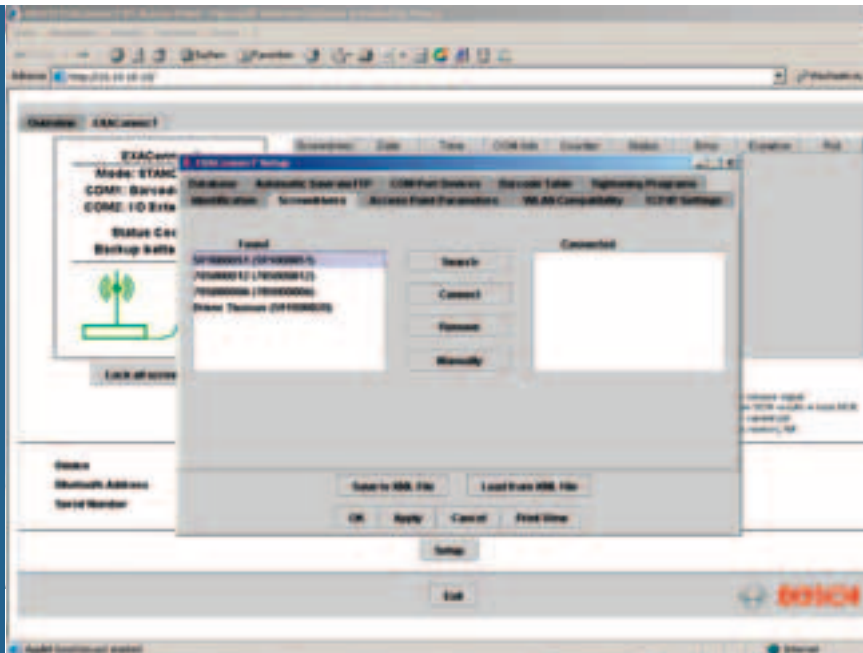

The system has separate setup screens for the EXACConnecT controller and the BT-EXACT tool. The setup screen shows part of the EXACConnecT setup menu. The system can be password protected to prevent unauthorized use.

Each BT-EXACT tool must be “found” and connected by the controller only one time; it will remain “connected” until removed by reprogramming.

Our unique system software can be configured to effectively stop the system from interfering with specific Wi-Fi channels to insure that it does not create interference in an assembly plant.

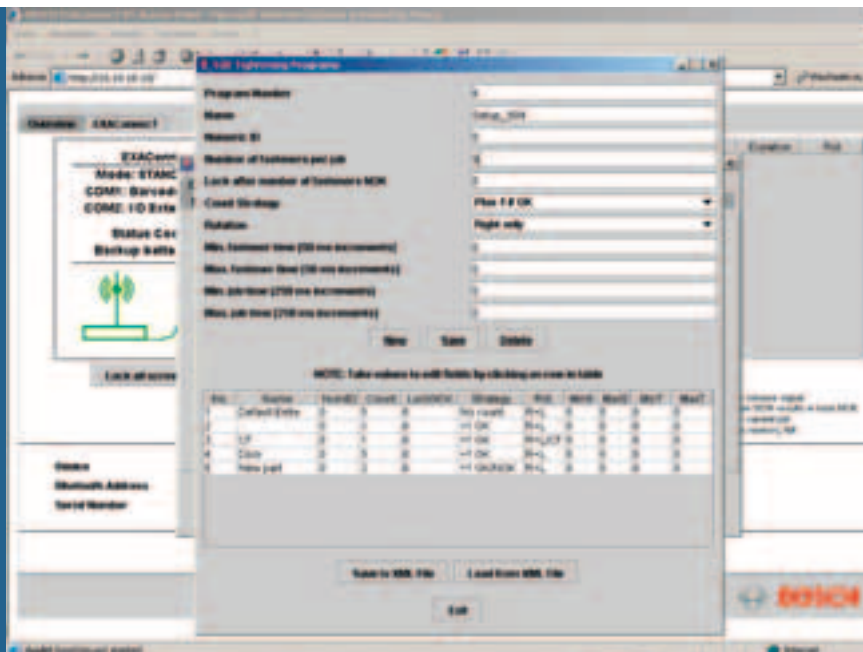

The screwdriver setup menu on the left controls everything from screw count to rework strategy to data output choices. The tool and controller can be setup to send and receive data from a variety of systems, including a host ethernet system, PLC systems, bar code scanners or our digital I/O module.

The system can also monitor screw run time to accurately determine crossthreading of screws or missing parts.

Rework strategies to evaluate the assembly process can be defined in detail, including customer-specific programming that is created by Bosch.

# EXAConnect wireless controller

## The core of the quality control system

The EXAConnect Bluetooth controller packs a lot of firepower in a small, easy to install package. The enclosure is IP 54 (NEMA 12) rated for dust and moisture resistance.

The controller has its own processor, flash memory and operating system, so it can run as a stand-alone unit or connect to a variety of controls.

Various status LED's and a 2-digit display that can be seen through the clear cover alert you of connection status or system errors.



The EXAConnect controller forms the link between your process control network and the Bluetooth equipped BT-EXACT cordless tool. Information about the screwdriving process can be exchanged bidirectionally in real time to insure that each BT-EXACT cordless tool knows exactly what it has to do and when to do it. One EXAConnect controller can run seven tools simultaneously, making it very cost-effective compared to other error proofing systems.

The EXAConnect controller can easily output data from up to 7 tools via the Ethernet connection, and up to 4 tools to a PLC via the 24 volt I/O switches. When controlling 7 tools via a PLC, an accessory digital I/O module is required. Refer to page 29 for details.

A wide-range power supply insures the system works anywhere in the world without the need for additional power transformers. An internal backup memory and real-time clock insure that critical data is always saved, even in the event of a power loss.

	Order number	Power supply	24 V power supply (output)	Standard interfaces
<b>EXAConnect Bluetooth Wireless Controller</b>	0 602 491 001	100 – 240 V, 50/60 Hz	max 4.8 W	Ethernet (TCP/IP) 2 x RS 422 4 x 24 V inputs 4 x 24 V outputs

System Software Requirements:  
 Operating system: MS Win 98 SE, 2000, NT, XP  
 Browser: Internet Explorer, Netscape Navigator, Mozilla Firefox  
 Plugin needed (Freeware): Java Runtime Environment 1.4.2 or higher

# Bluetooth digital I/O module

## Extend the reach of 7 tools to a PLC

The digital I/O box is used with the EXAConnect controller. It allows 24 volt I/O signals from up to seven tools to be sent to a PLC. The box is IP 54 (NEMA 12) rated for dust and moisture resistance.



The digital I/O module takes its power from the EXAConnect controller and receives its tool data from the controller RS 422 port. The box has 16 switched input/output connections for communicating with a PLC. Configuration is done via the EXAConnect software (in a web browser).

The EXAConnect controller is capable of supporting up to 4 tools (via a PLC) with limited I/O data transmission. The digital I/O module is needed when 2 to 7 tools must communicate detailed information with a PLC.

The I/O module is not required when using an Ethernet connection to a host network. There are different possible PLC configurations for any given situation; contact your distributor for details.







	Order number	Power requirement	Standard interfaces
<b>Bluetooth digital I/O module</b>	0 602 491 002	24 V	Ethernet (TCP/IP) 2 x RS 422 16 x 24 V inputs 16 x 24 V outputs



# BT-EXACT

## Cordless centre-grip screwdrivers

- ▶ Precision Shut-off clutch exceeds ISO tolerance of  $\pm 10\%$
- ▶ Lightweight
- ▶ Broad torque range
- ▶ Trigger repeat protection
- ▶ LED/audible battery charge indicators disable tool when voltage drops below threshold; tool stays “in-process” regardless of battery condition
- ▶ LED/audible shut-off indicator provides operator feedback for clutch signal to confirm good/bad joint status (sent via Bluetooth to controller)
- ▶ Bright LED light for work area illumination
- ▶ All models feature trigger hand forward/reverse control
- ▶ Tools share many common parts
- ▶ Color rings are used to identify joint types on the assembly line
- ▶ Protective rubber cover available for quick-change bit holder
- ▶ Tool holding fixtures available
- ▶ All models can be hung from balancer using accessory hook )
- ▶ All models require wireless EXAConnect controller

EXACT	Order number	Torque on hard joint per ISO 5393 (Nm)	Torque on soft joint per ISO 5393 (Nm)
<b>BT-EXACT 2</b> Bluetooth enabled 	0 602 491 433	0.6 – 2 (0.4 – 1.5 ft.-lbs.)	0.6 – 2 (0.4 – 1.5 ft.-lbs.)
	0 602 491 434	0.6 – 2 (0.4 – 1.5 ft.-lbs.)	0.6 – 2 (0.4 – 1.5 ft.-lbs.)
<b>BT-EXACT 4</b> Bluetooth enabled 	0 602 491 437	1 – 4 (0.7 – 3 ft.-lbs.)	1 – 4 (0.7 – 3 ft.-lbs.)
	0 602 491 438	1 – 4 (0.7 – 3 ft.-lbs.)	1 – 4 (0.7 – 3 ft.-lbs.)
<b>BT-EXACT 6</b> Bluetooth enabled 	0 602 491 431	1 – 6 (0.7 – 4.4 ft.-lbs.)	1 – 6 (0.7 – 4.4 ft.-lbs.)
	0 602 491 432	1 – 6 (0.7 – 4.4 ft.-lbs.)	1 – 6 (0.7 – 4.4 ft.-lbs.)
<b>BT-EXACT 7</b> Bluetooth enabled 	0 602 491 439	1.5 – 7 (1.1 – 5.2 ft.-lbs.)	1.5 – 7 (1.1 – 5.2 ft.-lbs.)
	0 602 491 440	1.5 – 7 (1.1 – 5.2 ft.-lbs.)	1.5 – 7 (1.1 – 5.2 ft.-lbs.)
<b>BT-EXACT 8</b> Bluetooth enabled 	0 602 491 443	1.5 – 8 (1.1 – 5.9 ft.-lbs.)	1.5 – 8 (1.1 – 5.9 ft.-lbs.)
	0 602 491 444	1.5 – 8 (1.1 – 5.9 ft.-lbs.)	1.5 – 8 (1.1 – 5.9 ft.-lbs.)
<b>BT-EXACT 9</b> Bluetooth enabled 	0 602 491 435	1.5 – 9 (1.1 – 6.7 ft.-lbs.)	1.5 – 9 (1.1 – 6.7 ft.-lbs.)
	0 602 491 436	1.5 – 9 (1.1 – 6.7 ft.-lbs.)	1.5 – 9 (1.1 – 6.7 ft.-lbs.)
<b>BT-EXACT 12</b> Bluetooth enabled 	0 602 491 441	1.5 – 12 (1.1 – 9 ft.-lbs.)	1.5 – 12 (1.1 – 9 ft.-lbs.)
	0 602 491 442	1.5 – 12 (1.1 – 9 ft.-lbs.)	1.5 – 12 (1.1 – 9 ft.-lbs.)

C-EXACT

EXACT

BT-EXACT

SEC-EXACT









ACCESSORIES

No-load speed ( $\text{min}^{-1}$ )	Bit holder	Battery specifications	Direction of rotation	Weight (kg / lbs)	Features	Included accessories
600	¼"		R/L	0.8 / 1.76	Class 2 Blue-tooth module	Torque adjustment tool light green color ring
600	¼"	9.6 V / 1.7 Ah	R/L	1.2 / 2.6	Class 2 Blue-tooth module	
900	¼"		R/L	0.8 / 1.76	Class 2 Blue-tooth module	Torque adjustment tool grey color ring
900	¼"	9.6 V / 1.7 Ah	R/L	1.2 / 2.6	Class 2 Blue-tooth module	
600	¼"		R/L	0.8 / 1.76	Class 2 Blue-tooth module	Torque adjustment tool black color ring
600	¼"	9.6 V / 1.7 Ah	R/L	1.2 / 2.6	Class 2 Blue-tooth module	
150	¼"		R/L	0.8 / 1.76	Class 2 Blue-tooth module	Torque adjustment tool white color ring
150	¼"	9.6 V / 1.7 Ah	R/L	1.2 / 2.6	Class 2 Blue-tooth module	
650	¼"		R/L	0.9 / 2.0	Class 2 Blue-tooth module	Torque adjustment tool orange color ring
650	¼"	12 V / 2.4 Ah	R/L	1.6 / 3.5	Class 2 Blue-tooth module	
350	¼"		R/L	0.8 / 1.76	Class 2 Blue-tooth module	Torque adjustment tool light blue color ring
350	¼"	9.6 V / 1.7 Ah	R/L	1.2 / 2.6	Class 2 Blue-tooth module	
400	¼"		R/L	0.9 / 2.0	Class 2 Blue-tooth module	Torque adjustment tool red color ring
400	¼"	12 V / 2.4 Ah	R/L	1.6 / 3.5	Class 2 Blue-tooth module	

# BT-ANGLE EXACT

## Cordless nutrunners

- ▶ Precision Shut-off clutch exceeds ISO tolerance of  $\pm 10\%$
- ▶ Lightweight
- ▶ Broad torque range
- ▶ Trigger repeat protection
- ▶ LED/audible battery charge indicator; same as T-grip
- ▶ LED/audible shut-off indicator; same as T-grip (sent via Bluetooth to controller)
- ▶ Bright LED light for work area illumination
- ▶ All models feature trigger hand forward/reverse control
- ▶ Tools share many common parts
- ▶ Color rings are used to identify joint types on the assembly line
- ▶ Protective rubber cover available for angle heads
- ▶ Uses same batteries/chargers as T-Grip models
- ▶ All models can be hung from balancer using suspension hook
- ▶ All Bluetooth models require wireless EXAConnect controller
- ▶ Tool weight with angle head and battery is 1.6kg/3.5 lbs (BT-ANGLE EXACT 17, 23, 30: 2.6kg/5.7 lbs)

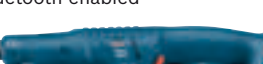
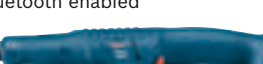
	Order number	Torque on hard joint per ISO 5393 (Nm)	Torque on soft joint per ISO 5393 (Nm)
<b>BT-ANGLE EXACT 2</b> Bluetooth enabled 	0 602 491 647	0.7 – 2 (0.5 – 1.5 ft.-lbs.)	0.7 – 2 (0.5 – 1.5 ft.-lbs.)
<b>BT-ANGLE EXACT 3</b> Bluetooth enabled 	0 602 491 656	0.7 – 3 (0.5 – 2.2 ft.-lbs.)	0.7 – 3 (0.5 – 2.2 ft.-lbs.)
<b>BT-ANGLE EXACT 6</b> Bluetooth enabled 	0 602 491 652	1.5 – 6 (1.1 – 4.4 ft.-lbs.)	1.5 – 6 (1.1 – 4.4 ft.-lbs.)
<b>BT-ANGLE EXACT 7</b> Bluetooth enabled 	0 602 491 669	2 – 7 (1.5 – 5.1 ft.-lbs.)	2 – 7 (1.5 – 5.1 ft.-lbs.)
<b>BT-ANGLE EXACT 8</b> Bluetooth enabled 	0 602 491 651	2 – 9 (1.5 – 6.7 ft.-lbs.)	2 – 8 (1.5 – 5.9 ft.-lbs.)
<b>BT-ANGLE EXACT 15</b> Bluetooth enabled 	0 602 491 650	2 – 15 (1.5 – 11 ft.-lbs.)	2 – 15 (1.5 – 11 ft.-lbs.)
<b>BT-ANGLE EXACT 17</b> Bluetooth enabled 	0 602 491 675	6 – 17 (4.4 – 12.5 ft.-lbs.)	6 – 13 (4.4 – 9.6 ft.-lbs.)
<b>BT-ANGLE EXACT 23</b> Bluetooth enabled 	0 602 491 673	7 – 23 (5.1 – 17 ft.-lbs.)	7 – 20 (5.1 – 14.8 ft.-lbs.)
<b>BT-ANGLE EXACT 30</b> Bluetooth enabled 	0 602 491 671	8 – 30 (5.9 – 22.1 ft.-lbs.)	8 – 28 (5.9 – 20.7 ft.-lbs.)



C-EXACT

EXACT

BT-EXACT

SEC-EXACT

ACCESSORIES

No-load speed (min <sup>-1</sup> )	Angle head	Battery specifications	Direction of rotation	Weight (kg / lbs)	Features	Included accessories
110	–	9.6 V (Not included)	R/L	1.0 / 2.2	Class 2 Blue-tooth module	Torque adjustment tool Housing wrench Suspension hook light-green marking ring
420	–	9.6 V (Not included)	R/L	1.0 / 2.2	Class 2 Blue-tooth module	Torque adjustment tool Housing wrench Suspension hook light-green marking ring
650	–	9.6 V (Not included)	R/L	1.0 / 2.2	Class 2 Blue-tooth module	Torque adjustment tool Housing wrench Suspension hook black marking ring
110	–	9.6 V (Not included)	R/L	1.0 / 2.2	Class 2 Blue-tooth module	Torque adjustment tool Housing wrench Suspension hook orange marking ring
420	–	9.6 V (Not included)	R/L	1.0 / 2.2	Class 2 Blue-tooth module	Torque adjustment tool Housing wrench Suspension hook orange marking ring
250	–	9.6 V (Not included)	R/L	1.0 / 2.2	Class 2 Blue-tooth module	Torque adjustment tool Housing wrench Suspension hook red marking ring
560	–	14.4 V (Not included)	R/L	1.5 / 3.3	Class 2 Blue-tooth module	Torque adjustment tool Housing wrench Suspension hook white color ring
320	– requires HD angle head	14.4 V (Not included)	R/L	1.5 / 3.3	Class 2 Blue-tooth module	Torque adjustment tool Housing wrench Suspension hook orange color ring
220	– requires HD angle head	14.4 V (Not included)	R/L	1.5 / 3.3	Class 2 Blue-tooth module	Torque adjustment tool Housing wrench Suspension hook red color ring







## The new generation EXACT:

Saving time and money is guaranteed with the new SEC Motor from Bosch.

Higher efficiency was the key development target for the new series of Bosch EXACT Cordless Screwdrivers with the SEC motor. This sensor less and brushless motor technology sets the bench mark in terms of low energy consumption, lowest weight and highest power (torque and speed). To top it all off, the tools' accuracy was increased.



# Faster, Lighter, Greater Durability & Accuracy!

Bosch SEC-EXACT cordless assembly tools make the assembly process easier, faster, safer and more accurate. Thanks to our patented SEC motors, our ability to control shut-off via motor braking is better than ever. This means that the SEC-EXACT is the most accurate cordless tool Bosch has ever made. Improving on the best clutch in the world wasn't easy, but we know you expect nothing less from the world leader in cordless assembly tools.

## **Bosch SEC-EXACT tools will improve your productivity. To sum it all up in a word: SEC = M<sup>2</sup>!**

The SEC-EXACT cordless series provides between a 50 to 100% speed increase over the standard EXACT range. Couple that with a weight reduction in select models that provides a 70% better power to weight ratio, and your productivity is sure to dramatically improve. For example, the new SEC-EXACT 412 drops 300 grams compared to the standard EXACT 12, thanks to the use of a 9.6 volt battery. The increased motor efficiency of the SEC range means that all center-grip models need only a 9.6 volt battery to perform better than ever.

The Bosch SEC motor has no brushes to wear out. But the most important feature is that this patented technology developed by Bosch does not need a sensor to know rotor speed and position! This provides a very efficient, wear-free motor system compared to any other brushless motor from any manufacturer in the world. This 3-phase brushless, sensor-less motor is designed and manufactured by Bosch in Europe, thus insuring the highest quality standards are met and maintained.

- ▶ Achieve faster line speeds thanks to shorter tightening cycles: Work moves faster thanks to speed increases up to 100%.
- ▶ Improved ergonomics, weight and reaction force translates into satisfied, productive workers that like using the SEC-EXACT tools.
- ▶ Reduces life-cycle costs due to wear-free components
- ▶ Bosch SEC motors are the most efficient, durable and economical motors of their type in the world. Nothing else comes close.

# SEC = M<sup>2</sup>\*

\* M<sup>2</sup> = The faster, more efficient and more economical Bosch motor!

**Brushless, sensor-less****Bosch SEC motor**

Designed, made and patented  
by Bosch in Europe.

**Plug-in Electric  
connectors**

For easy service  
when needed.

**Non-contact left/right switch**

features wear-free components.

**Integrated switch and PCB module**

Non-contact components are wear-  
free and overload protected.

**Battery pack connectors**

Replaceable separately.









# SEC-EXACT

## Cordless center-grip screwdrivers

### Cordless center-grip screwdrivers

#### SEC-EXACT

- ▶ Highest repeatability:  
Improved accuracy!  $Cmk \geq 2,0$   
Also the reaction forces could be improved.
- ▶ Lowest weight in class:  
The new SEC-EXACT models use the 9.6 volt batteries only, reducing weight by 300 grams!
- ▶ Huge speed range of the complete series
- ▶ Broad torque range
- ▶ Illumination of the work area.
- ▶ Overload protection for the PCB, the motor and the battery pack.
- ▶ Best ergonomics:  
Small size and very well balanced.  
One handed operation for On/Off and Left/Right.
- ▶ Robust and durable tool with the well known components of the EXACT range.
- ▶ Proven and highly efficient battery technology in production quality.  
You can still use your existent charging technology, battery packs and protective covers.

SEC-EXACT	Order number	Torque on hard joint per ISO 5393 (Nm)	Torque on soft joint per ISO 5393 (Nm)
<b>SEC-EXACT 1106</b> highest speed for short cycle times 	0 602 492 431	1 – 6 (0.7 – 4.4 ft.-lbs.)	1 – 6 (0.7 – 4.4 ft.-lbs.)
	0 602 492 432	1 – 6 (0.7 – 4.4 ft.-lbs.)	1 – 6 (0.7 – 4.4 ft.-lbs.)
<b>SEC-EXACT 908</b> combination of speed and torque 	0 602 492 443	2 – 8 (1.5 – 5.9 ft.-lbs.)	2 – 8 (1.5 – 5.9 ft.-lbs.)
	0 602 492 444	2 – 8 (1.5 – 5.9 ft.-lbs.)	2 – 8 (1.5 – 5.9 ft.-lbs.)
<b>SEC-EXACT 610</b> power and speed 	0 602 492 445	2 – 10 (1.5 – 7.4 ft.-lbs.)	2 – 10 (1.5 – 7.4 ft.-lbs.)
	0 602 492 446	2 – 10 (1.5 – 7.4 ft.-lbs.)	2 – 10 (1.5 – 7.4 ft.-lbs.)
<b>SEC-EXACT 459</b> the model fits every application 	0 602 492 435	2 – 9 (1.5 – 6.7 ft.-lbs.)	2 – 9 (1.5 – 6.7 ft.-lbs.)
	0 602 492 436	2 – 9 (1.5 – 6.7 ft.-lbs.)	2 – 9 (1.5 – 6.7 ft.-lbs.)
<b>SEC-EXACT 412</b> high torque with low weight 	0 602 492 441	2 – 12 (1.5 – 9 ft.-lbs.)	2 – 12 (1.5 – 9 ft.-lbs.)
	0 602 492 442	2 – 12 (1.5 – 9 ft.-lbs.)	2 – 12 (1.5 – 9 ft.-lbs.)
<b>SEC-EXACT 402</b> very precise in the lower torque range 	0 602 492 433	0.5 – 2 (0.4 – 1.5 ft.-lbs.)	0.5 – 2 (0.4 – 1.5 ft.-lbs.)
	0 602 492 434	0.5 – 2 (0.4 – 1.5 ft.-lbs.)	0.5 – 2 (0.4 – 1.5 ft.-lbs.)
<b>SEC-EXACT 212</b> slow screwdriver e.g. for hose clamps 	0 602 492 439	2 – 12 (1.5 – 9 ft.-lbs.)	2 – 12 (1.5 – 9 ft.-lbs.)
	0 602 492 440	2 – 12 (1.5 – 9 ft.-lbs.)	2 – 12 (1.5 – 9 ft.-lbs.)



No-load speed ( $\text{min}^{-1}$ )	Bit holder	Battery specifications	Direction of rotation	Weight (kg / lbs)	Features	Included accessories
1100	¼"	–	R/L	0.8 / 1.76	0.7 repeat protection	Torque adjustment tool black color ring
1100	¼"	9.6 V / 1.7 Ah	R/L	1.2 / 2.6	0.7 repeat protection	
900	¼"	–	R/L	0.8 / 1.76	0.7 repeat protection	Torque adjustment tool orange color ring
900	¼"	9.6 V / 1.7 Ah	R/L	1.2 / 2.6	0.7 repeat protection	
600	¼"	–	R/L	0.8 / 1.76	0.7 repeat protection	Torque adjustment tool grey color ring
600	¼"	9.6 V / 1.7 Ah	R/L	1.2 / 2.6	0.7 repeat protection	
450	¼"	–	R/L	0.8 / 1.76	0.7 repeat protection	Torque adjustment tool light blue ring
450	¼"	9.6 V / 1.7 Ah	R/L	1.2 / 2.6	0.7 repeat protection	
400	¼"	–	R/L	0.8 / 1.76	0.7 repeat protection	Torque adjustment tool red color ring
400	¼"	9.6 V / 1.7 Ah	R/L	1.2 / 2.6	0.7 repeat protection	
400	¼"	–	R/L	0.8 / 1.76	0.7 repeat protection	Torque adjustment tool light green color ring
400	¼"	9.6 V / 1.7 Ah	R/L	1.2 / 2.6	0.7 repeat protection	
275	¼"	–	R/L	0.8 / 1.76	0.7 repeat protection	Torque adjustment tool white color ring
275	¼"	9.6 V / 1.7 Ah	R/L	1.2 / 2.6	0.7 repeat protection	

# SEC-ANGLE EXACT

## Cordless nutrunners

### Cordless nutrunners

#### SEC-ANGLE EXACT

- ▶ Highest repeatability:  
Improved accuracy!  $Cmk \geq 2,0$   
Also the reaction forces could be improved.
- ▶ Lowest weight in class:  
The new SEC-ANGLE EXACT models up to 25 Nm use only 9.6 volt batteries, reducing weight by 400 grams!
- ▶ Broad speed range of the complete series
- ▶ Broad torque range
- ▶ Adjustable angle heads for best ergonomics.
- ▶ Illumination of the work area.
- ▶ Overload protection for the PCB, the motor and the battery pack.
- ▶ Best ergonomics:  
Small size and very well balanced.  
One handed operation for On/Off and Left/Right.
- ▶ Robust and durable tool with the well known components of the ANGLE EXACT range.
- ▶ Proven and highly efficient battery technology in production quality.  
You can still use your existent charging technology, battery packs and protective covers.

SEC-ANGLE EXACT!	Order number	Torque on hard joint per ISO 5393 (Nm)	Torque on soft joint per ISO 5393 (Nm)
<b>SEC-ANGLE EXACT 7-900</b> 	0 602 492 611	2 – 7 (1.5 – 5.1 ft.-lbs.)	2 – 6.5 (1.5 – 4.8 ft.-lbs.)
	0 602 492 612	2 – 7 (1.5 – 5.1 ft.-lbs.)	2 – 6.5 (1.5 – 5.1 ft.-lbs.)
<b>SEC-ANGLE EXACT 10-650</b> 	0 602 492 609	2 – 10 (1.5 – 7.4 ft.-lbs.)	2 – 9 (1.5 – 6.6 ft.-lbs.)
	0 602 492 610	2 – 10 (1.5 – 7.4 ft.-lbs.)	2 – 9 (1.5 – 6.6 ft.-lbs.)
<b>SEC-ANGLE EXACT 14-420</b> 	0 602 492 607	2 – 14 (1.5 – 10 ft.-lbs.)	2 – 14 (1.5 – 10 ft.-lbs.)
	0 602 492 608	2 – 14 (1.5 – 10 ft.-lbs.)	2 – 14 (1.5 – 10 ft.-lbs.)
<b>SEC-ANGLE EXACT 25-250</b> 	0 602 492 605	10 – 25 (7.4 – 18.4 ft.-lbs.)	10 – 20 (7.4 – 14.7 ft.-lbs.)
	0 602 492 606	10 – 25 (7.4 – 18.4 ft.-lbs.)	10 – 20 (7.4 – 14.7 ft.-lbs.)
<b>SEC-ANGLE EXACT 30-380</b> 	0 602 492 603	10 – 25 (7.4 – 22.1 ft.-lbs.)	10 – 25 (7.4 – 18.4 ft.-lbs.)
	0 602 492 604	10 – 30 (7.4 – 22.1 ft.-lbs.)	10 – 25 (7.4 – 22.1 ft.-lbs.)
<b>SEC-ANGLE EXACT 40-280</b> 	0 602 492 601	10 – 40 (7.4 – 29.5 ft.-lbs.)	10 – 35 (7.4 – 25.8 ft.-lbs.)
	0 602 492 602	10 – 40 (7.4 – 29.5 ft.-lbs.)	10 – 35 (7.4 – 25.8 ft.-lbs.)
<b>SEC-ANGLE EXACT 50-210</b> 	0 602 492 613	10 – 50 (7.4 – 36.9 ft.-lbs.)	10 – 45 (7.4 – 33.1 ft.-lbs.)
	0 602 492 614	10 – 50 (7.4 – 36.9 ft.-lbs.)	10 – 45 (7.4 – 33.1 ft.-lbs.)

No-load speed (min <sup>-1</sup> )	Angle head	Battery specifications (V)	Direction of rotation	Weight (kg / lbs)	Features	Included accessories
900	–	–	R/L	1.0 / 2.2	0.7 repeat protection	Torque adjustment tool Spanner Hanger light blue color ring
900	–	9.6 V / 1.7 Ah	R/L	1.4 / 3.1	0.7 repeat protection	
650	–	–	R/L	1.0 / 2.2	0.7 repeat protection	Torque adjustment tool Spanner Hanger light green color ring
650		9.6 V / 1.7 Ah	R/L	1.4 / 3.1	0.7 repeat protection	
420	–	–	R/L	1.0 / 2.2	0.7 repeat protection	Torque adjustment tool Spanner Hanger white color ring
420		9.6 V / 1.7 Ah	R/L	1.4 / 3.1	0.7 repeat protection	
245	3/8" square	–	R/L	1.57 / 3.5	0.7 repeat protection	Torque adjustment tool Spanner Hanger grey blue color ring
245	3/8" square	9.6 V / 1.7 Ah	R/L	2.0 / 4.4	0.7 repeat protection	
380	3/8" square	–	R/L	1.58 / 3.5	0.7 repeat protection	Torque adjustment tool Spanner Hanger orange color ring
380	3/8" square	14.4 V / 2.4 Ah	R/L	2.3 / 5.1	0.7 repeat protection	
280	3/8" square	–	R/L	1.58 / 3.5	0.7 repeat protection	Torque adjustment tool Spanner Hanger red color ring
280	3/8" square	14.4 V / 2.4 Ah	R/L	2.3 / 5.1	0.7 repeat protection	
210	3/8" square	–	R/L	1.58 / 3.5	0.7 repeat protection	Torque adjustment tool Spanner Hanger black color ring
210	3/8" square	14.4 V / 2.4 Ah	R/L	2.3 / 5.1	0.7 repeat protection	





C-EXACT

EXACT

BT-EXACT

SEC-EXACT

ACCESSORIES



## **Production process secured:** Original EXACT Accessories

Smart battery chargers, Bosch class zero batteries, 4-EXACT power supply,  
general accessories and tool dimensions

# Smart battery chargers.

Bosch battery chargers use intelligent microprocessors to evaluate and charge batteries efficiently, quickly and carefully.

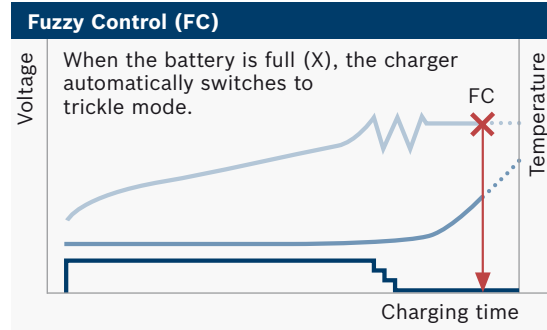
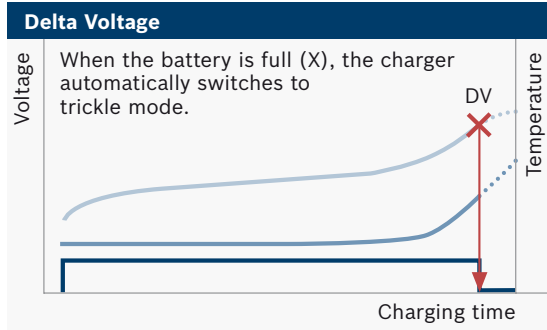

## Delta voltage one hour charger

The Bosch delta voltage charger is a one hour charger that continually regulates itself. If a battery begins to overcharge, the cells recognize a characteristic voltage drop known as negative delta voltage. This value is used as a control to trigger a drop in the charging current or reduce current to a trickle charge, preventing overcharging. Battery life using this charger is about 1,400 to 1,500 charge/discharge cycles.

## Fuzzy logic 15-minute charger

The Bosch fuzzy logic charger is a 15-minute quick charger that calculates required charge time based on battery voltage and temperature. This process greatly extends battery life, and does not require fully discharging a battery before recharging. Battery life can be increased to as many as 3,000 charge/discharge cycles.

	Order number	Voltage (V)	Weight (kg / lbs)
<b>AL 60 DV 1,9 A</b> One hour charger. Charges all Bosch NTC battery packs from 7.2 to 14.4 volts with APT insertion end.	2 607 224 439	230	1.2 / 2.6
	2 607 224 445 (US version)	115	1.2 / 2.6
<b>AL 15 FC 2498</b> Features fuzzy logic charging technology. The 15-minute charger for all Bosch NTC battery packs from 7.2 to 24 V with APT insertion end. Also provides audible signal that battery is fully charged.	2 607 224 483	230	1.0 / 2.2
	2 607 224 489 (US version)	115	1.0 / 2.2







# Production batteries.

Bosch production tool batteries: not just your average Ni-cad



Our batteries may resemble a conventional Bosch battery on the outside, but the cells inside are unique in the world of power tools. We use class “zero” cells to produce the longest-lasting, best performing batteries in the business.

These high-grade battery cells are manufactured in limited batches using improved tolerances and processes over standard Ni-cad cells. Expect up to 3,000 charge cycles using our 15-minute charger.

	Order number	Description	Voltage (V)	Capacity (Ah)	Weight (kg / lbs)
<b>9,6 V Batteries</b> 	2 607 335 373	Single Battery	9.6	1.7	0.4 / 0.9
	0 602 490 002	Battery 10-pack	9.6	1.7	4 / 9
	2 607 335 453	US version of 2 607 335 373			
	2 607 335 659	Single Battery	9.6	2.4	0.5 / 1
	0 602 490 009	Battery 10-pack	9.6	2.4	5 / 10
<b>12 V Batteries</b> 	2 607 335 374	Single Battery	12	1.7	0.6 / 1.3
	0 602 490 003	Battery 10-pack	12	1.7	6 / 13
	2 607 335 454	US version of 2 607 335 374			
	2 607 335 375	Single Battery	12	2.4	0.7 / 1.5
	0 602 490 004	Battery 10-pack	12	2.4	0.7 / 15
<b>14.4 V Batteries</b> 	2 607 335 657	Single Battery	14.4	1.7	0.7 / 1.5
	0 602 490 008	Battery 10-pack	14.4	1.7	7 / 15
	2 607 335 655	Single Battery	14.4	2.4	0.8 / 1.8
	0 602 490 007	Battery 10-pack	14.4	2.4	8 / 18

## Average number of fasteners per battery charge

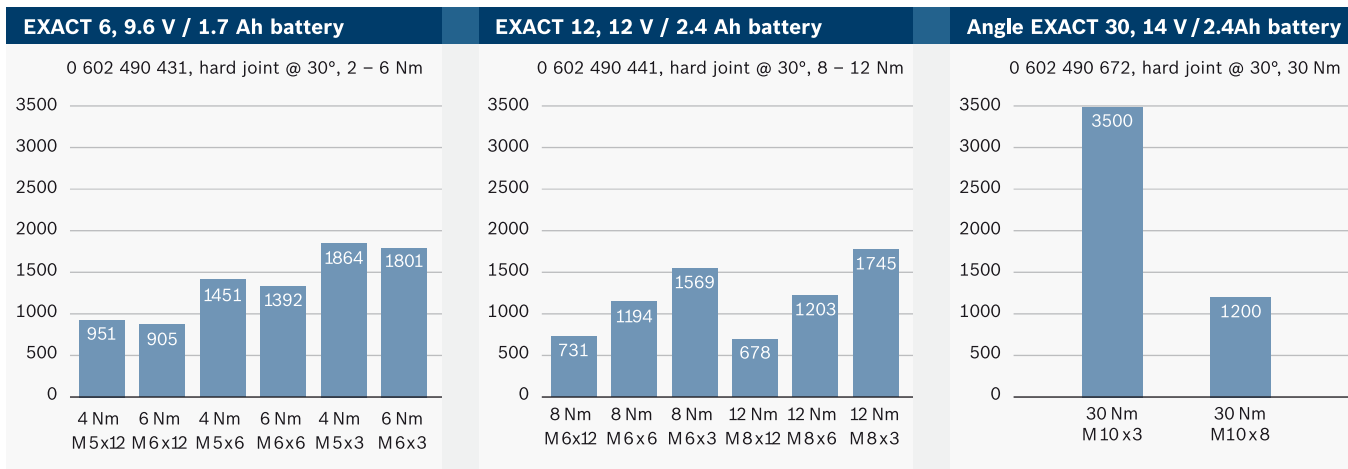

# The 4-EXACT power supply – constant power for work stations.



Constant power supply for the EXACT and ANGLE EXACT tools.  
Not applicable with the new SEC-EXACT and SEC-ANGLE EXACT tools.

The 4-EXACT Power supply is designed to provide a constant power source to all EXACT and Angle EXACT tools. The 4-EXACT is ideal for assembly situations where cordless mobility is not needed (or desired). It uses an “empty” battery housing as an adapter connected to a 5 meter cable that plugs directly into the unit.

The system can be used in conjunction with our Bluetooth error-proofing controller. Now you can use the same tool for mobile and stationary applications, while reducing your maintenance and spare parts costs.

- ▶ Automatically detects the correct voltage for the right tool
- ▶ Limits worker movement to 5 meters/16 ft
- ▶ Power supply weight is 13.6 kg /30 lbs

	Order number
<b>Bosch 4 EXACT Power Supply 230 V</b> 	0 602 490 507
<b>Bosch 4 EXACT Power Supply 110 V</b> 	0 602 490 508



	Order number
<b>Adapter cable 9,6 V</b> 	0 602 490 503
<b>Adapter cable 12 V</b> 	0 602 490 504
<b>Adapter cable 14,4 V</b> 	0 602 490 505

A 5 meter/16 foot long cable connects any EXACT or Angle EXACT to the power supply. The cable and adapter allow for easy conversion of a cordless tool to an “electric” tool.



# C-EXACT / PUC-EXACT

## Accessories and dimensions

Accessories		Order number	Quantity
<b>Protective rubber sleeve</b> for all 3/4" quick change chucks prevents mutilation of work piece		3 605 500 172	5
<b>Snap-in color rings</b> for quick torque range identification fits all C-EXACT straight screwdrivers and all T-grip EXACT cordless drivers			
	black	3 600 106 010	5
	red	3 600 106 011	5
	light blue	3 600 106 012	5
	light green	3 600 106 013	5
	orange	3 600 106 014	5
	grey	3 600 106 017	5
	white	3 600 106 019	5
	mixed	3 600 106 015	5

### C-EXACT lever start

Dimensions in mm

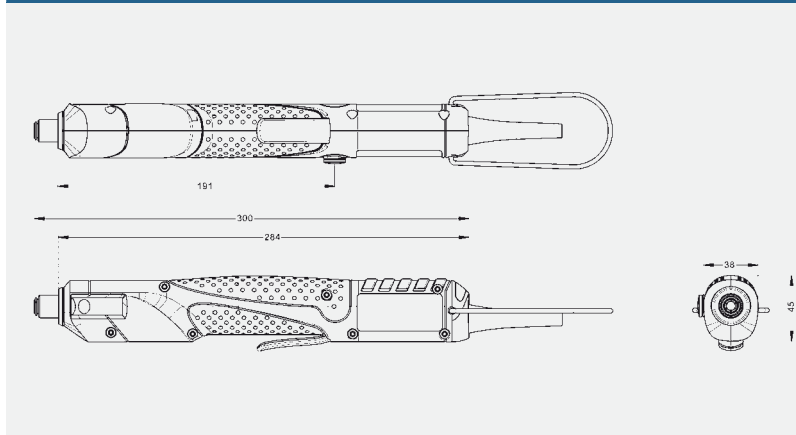

### PUC-EXACT 1

Dimensions in mm

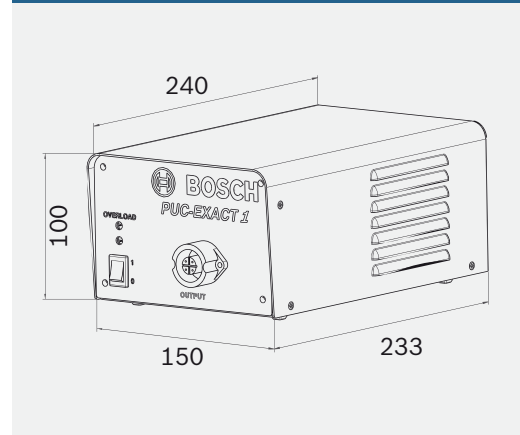

### C-EXACT push start

Dimensions in mm

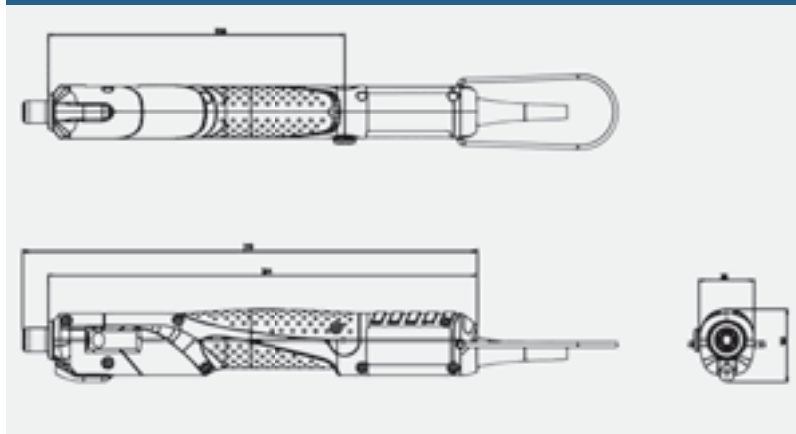

### PUC-EXACT 3



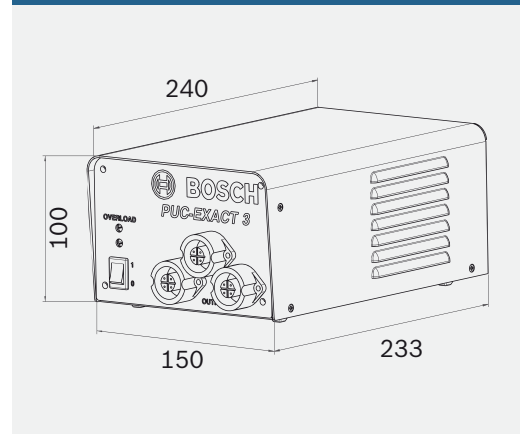











Dimensions in mm





# EXACT and SEC-EXACT





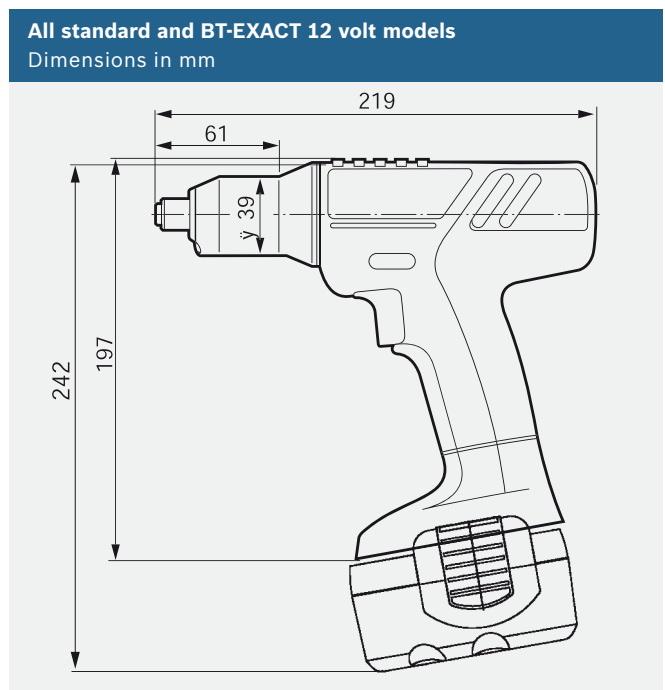
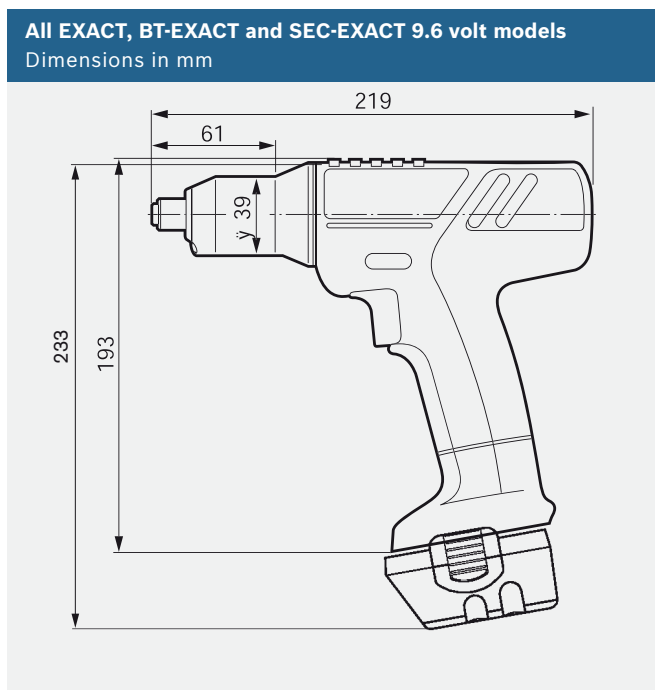

## Accessories and dimensions

Accessories		Order number	Quantity
<b>Protective rubber sleeve</b> for all 1/4" quick change chucks prevents mutilation of work piece		3 605 500 172	5
<b>Snap-in color rings</b> for quick torque range identification fits all C-EXACT straight screwdrivers and all T-grip EXACT cordless drivers	 black  red  light blue  light green  orange  grey  white  mixed	3 600 106 010 3 600 106 011 3 600 106 012 3 600 106 013 3 600 106 014 3 600 106 017 3 600 106 019 3 600 106 015	5 5 5 5 5 5 5 5
<b>T-grip bench mount tool holder</b> (for all T-grip tools only)		0 602 490 001	10
<b>Protective cover</b> Prevents damage to work piece; Fits all T-grip EXACT cordless drivers will not block motor air vents sold as a 10-pack only	 transparent  red  blue  green	0 602 490 011 0 602 490 012 0 602 490 013 0 602 490 014	10 10 10 10



# ANGLE EXACT and ANGLE EXACT CF

## Accessories

Accessories	Order number	Quantity	
<b>Snap-in color rings</b> for quick torque range identification fits all C-EXACT straight screwdrivers and all T-grip EXACT cordless drivers	 black	3 600 106 027	5
	 red	3 600 106 028	5
	 light blue	3 600 106 029	5
	 light green	3 600 106 030	5
	 orange	3 600 106 031	5
	 grey	3 600 106 032	5
	 white	3 600 106 033	5

	Order number	Max. Torque (Nm)	Drive	Weight (kg/lbs)	Quantity
<b>Straight head</b> 	0 607 453 631	6	1/4" quick-change	0.2 / 0.4	1
<b>Angle head</b> for ANGLE EXACT 2, 3, 6, 7, 8, 15, 17, 23, 7-900, 10-650, 14-420 Gear ratio is 1.4:1	 0 607 453 617	27	1/4" square	0.2 / 0.4	1
	 0 607 453 618	27	1/4" internal hex	0.2 / 0.4	1
	 0 607 453 620	27	3/8" square	0.2 / 0.4	1
	 0 607 453 630	27	1/4" quick-change	0.2 / 0.4	1
<b>Heavy-duty angle head</b> required for ANGLE EXACT 30; Gear ratio is 1.4:1 	0 607 451 618	35	3/8" square	0.22 / 0.5	1
<b>Protective cover</b> for angle heads 	fits 0 607 453 617, -618, -620, -630	3 605 500 171	-	-	1
	fits 0 607 451 618	3 605 500 175	-	-	1
<b>Protective cover</b> Prevents damage to work piece; Fits SEC-ANGLE EXACT 25-250, 30-380, 40-280, 50-210	3 609 202 A29	-	-	-	1

# ANGLE EXACT and ANGLE EXACT CF

## Dimensions

**ANGLE EXACT models: 2, 3, 6, 7, 8, 15, 14 CF; all 9.6 volt models**  
Dimensions in mm

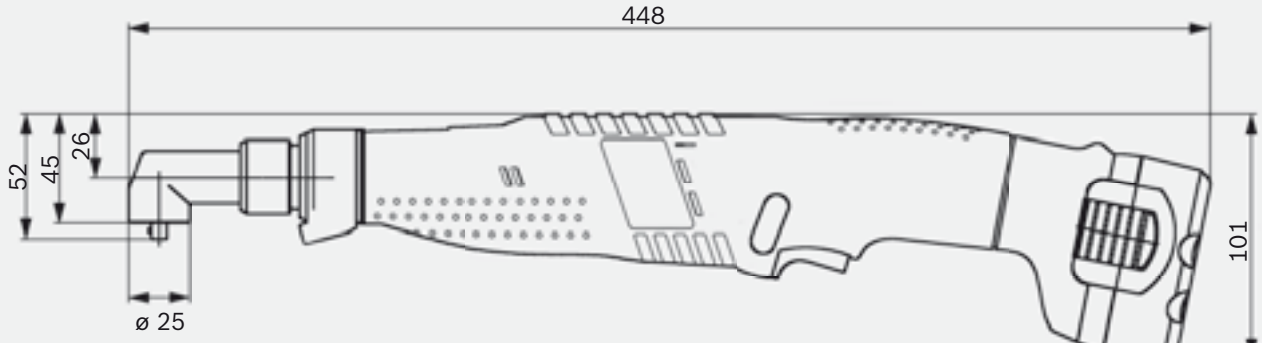

**ANGLE EXACT models: 17, 23, 30, 22 CF, 29 CF all 14.4 volt models**  
Dimensions in mm

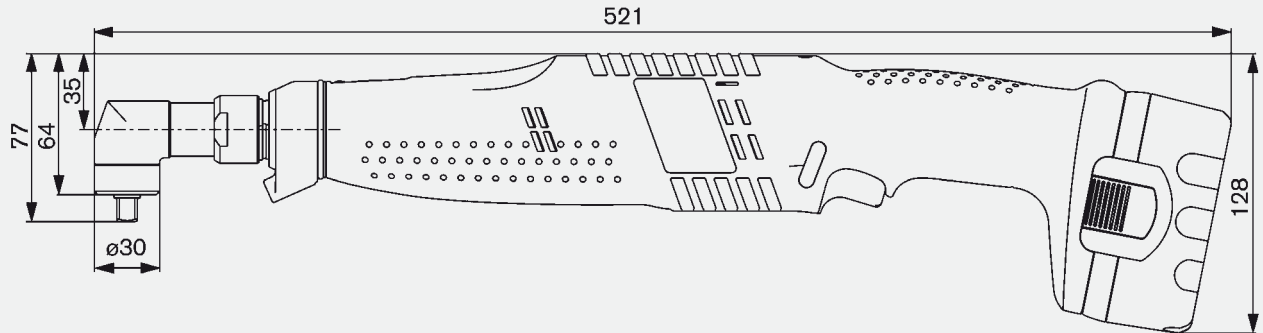

**0 607 453 631** Dimensions in mm

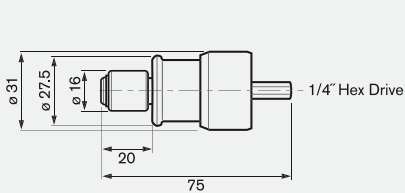

**0 607 453 617** Dimensions in mm

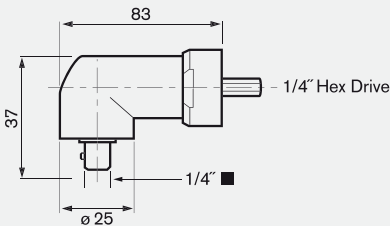

**0 607 453 618** Dimensions in mm

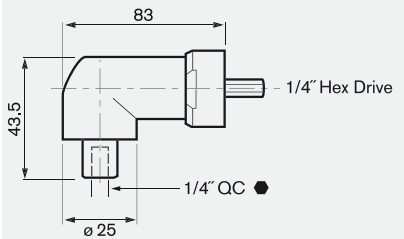

**0 607 453 620** Dimensions in mm

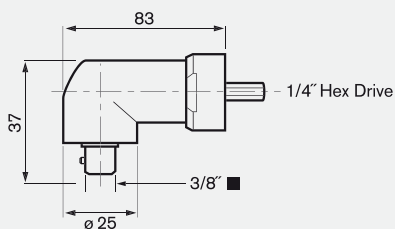

**0 607 453 630** Dimensions in mm

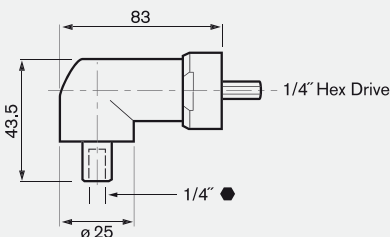

**0 607 451 618** Dimensions in mm

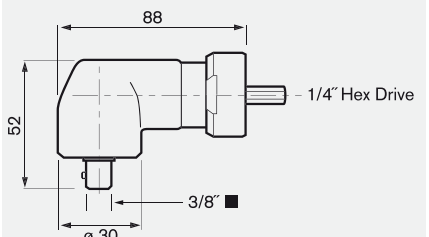



# SEC-ANGLE EXACT

## Dimensions

SEC-ANGLE EXACT models: 50-210, 40-280, 30-380

Dimensions in mm

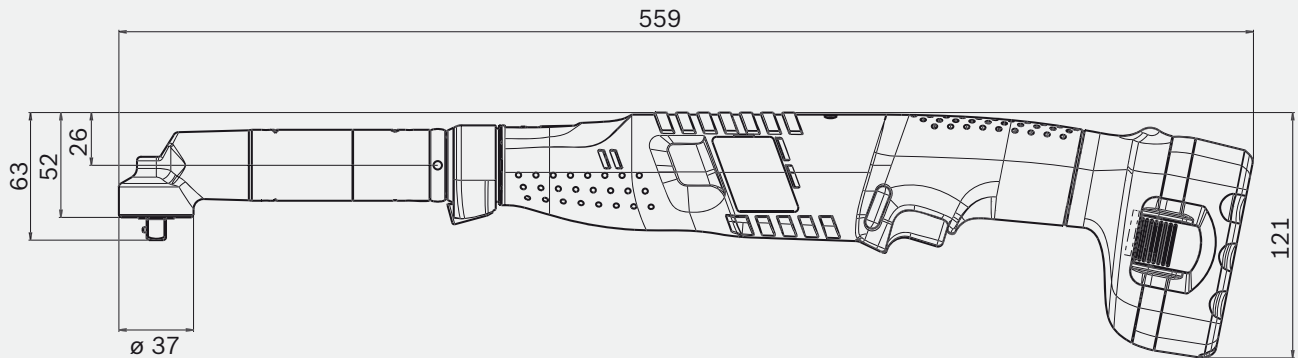

SEC-ANGLE EXACT model: 25-250

Dimensions in mm

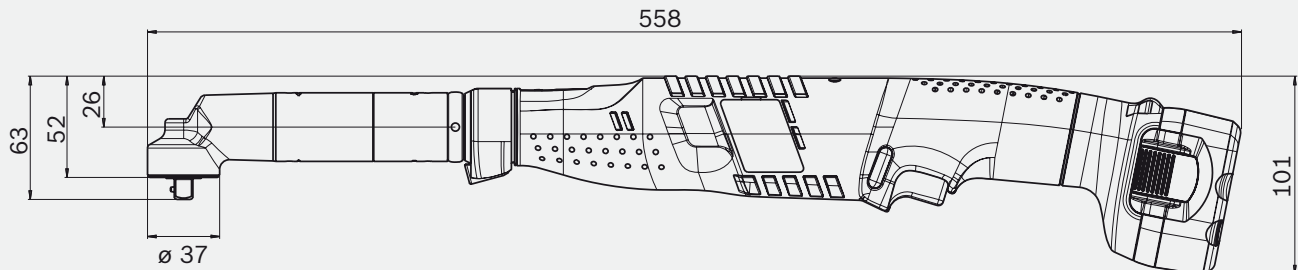

SEC-ANGLE EXACT models: 7-900, 10-650, 14-420

Dimensions in mm

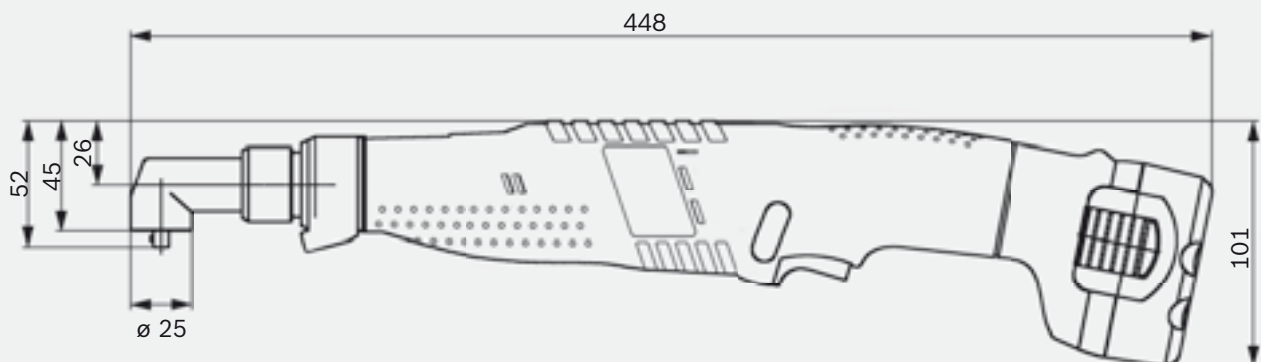

# Bosch service quality



## The Bosch CD-ROM Service Information System

provides information about Bosch Power Tools over the past 25 years – including spare parts lists and exploded drawings, thus saving time and money on spare parts management.



## Bosch Fax Service

offers direct, cost-effective access to important service documents such as spare parts lists, exploded drawings and forms. Information can be accessed 24 hours a day – even on Sundays and bank holidays. Not available in all countries.



## Bosch Spare Parts Service

guarantees in 99% of all cases that the desired spare part is available ex stock, allowing work to continue quickly.



## Bosch Recycling Service

offers environmental protection that anybody can actively take part in. Bosch Industrial Tools, cordless tools and battery packs that are past their service life are taken back at no charge via specialist retailers or directly and sent for recycling.

**Robert Bosch GmbH**  
Power Tool Division  
Marketing, Sales Production Tools

P.O. Box 10 01 56  
D-70745 Leinfelden-Echterdingen  
e-mail: [ProductionTools@de.bosch.com](mailto:ProductionTools@de.bosch.com)  
[www.boschproductiontools.com](http://www.boschproductiontools.com)

1 619 DA0 317 (06.08)  
Printed in Federal Republic of Germany.  
Imprimé en République Fédérale  
d'Allemagne. Subject to technical altera-  
tions. No liability can be accepted for  
printing errors.

CENTRALA TECHNICZNA  
**ELTECH**®

